

IB IL EX-IS DIO 4/NAM-PAC

Intrinsically safe Inline digital I/O terminal
for hazardous locations



Data sheet
2846_en_D

© PHOENIX CONTACT 2015-04-07

1 Description

The IB IL EX-IS DIO 4/NAM-PAC terminal is an intrinsically safe, digital input/output unit for sensor and actuator connection directly into Zone 1, 0 or Class I, Division 2 (see “Conformance/approvals” on page 4 for specific listings). It also supports proximity sensors as per EN 60947-5-6 (NAMUR).

The terminal and accompanying intrinsically safe power supply (IB IL EX-IS PWR IN-PAC) is installed in Zone 2 or a safe area.

The terminal provides four independently configurable digital channels for digital inputs, such as dry contacts, NAMUR sensors and optocouplers, and outputs, such as buzzers, signal lamps, LEDs or solenoid valves.

2 Features

- Four channels are configured independently of one another as either an input or output channel
- Four 8.2 V DC (loop-powered) inputs for connection of digital sensors, such as dry contacts
- Accepts NAMUR sensor inputs or sensors with NAMUR network
- Connection of sensors in 2-wire technology
- Maximum permissible load current at each output channel: 45 mA
- Four digital outputs for connection of digital switches
- Individual channel diagnostic indicators
- Remote diagnostics via process data channel
- -25... +60°C operating range



This data sheet is only valid in association with the IB IL SYS PRO UM E user manual or the Inline system manual for your bus system.

The use of this terminal requires connection via the IB IL EX-IS PWR IN-PAC (Order No. 2869910). The data sheet can be downloaded at phoenixcontact.com.



Make sure you always use the latest documentation.
It can be downloaded at phoenixcontact.com.



This data sheet is valid for all products listed on page 3.

1	Description.....	1
2	Features	1
3	Ordering data.....	3
4	Technical data	3
5	Internal circuit diagram	5
6	Electrical isolation	6
7	Local diagnostic and status indicators and terminal point assignment	6
	7.1 Function identification.....	6
	7.2 Local diagnostic and status indicators.....	6
	7.3 Terminal point assignment for each connector	6
8	Safety regulations installation notes	7
	8.1 Special conditions for safe use.....	7
	8.2 Safety instructions	7
	8.3 FM compliance.....	8
9	Installation instructions	8
	9.1 Overview	8
	9.2 Power budget.....	9
10	Connection examples	10
11	Programming data/configuration data.....	11
	11.1 INTERBUS	11
	11.2 Other bus systems	11
12	Configuration and read/write via process data.....	11
	12.1 Output	11
	12.2 Input data/diagnostics	12

3 Ordering data

Products

Description	Type	Order No.	Pcs./Pkt.
Terminal with four digital channels; selectable as either input or output 500 kbps transmission speed; includes accessories (connectors and labeling fields)	IB IL EX-IS DIO 4/NAM-PAC	2869911	1

Documentation

Description	Type	Order No.	Pcs./Pkt.
User manual: "Configuring and Installing the INTERBUS Inline Product Range"	IB IL SYS PRO UM E	2743048	1
User manual: "Automation Terminals of the Inline Product Range"	IL SYS INST UM E	2698737	1

4 Technical data

General data

Housing dimensions (width x height x depth)	48.8 mm x 136.8 mm x 71.5 mm
Weight	204 g
Operating mode	Process data mode with 1 word
Transmission speed	500 kbps
Permissible temperature (operation)	-25°C to +60°C
Permissible temperature (storage/transport)	-25°C to +85°C
Permissible humidity (operation/storage/transport)	10% to 95%, according to DIN EN 61131-2
Permissible air pressure (operation/storage/transport)	70 kPa to 106 kPa (up to 3000 m above sea level)
Degree of protection	IP20 according to IEC 60529
Protection class	Class 3 according to VDE 0106, IEC 60536
Connection method	Spring-cage terminals
Conductor cross section	0.2 mm ² - 1.5 mm ² (solid or stranded), 24 - 16 AWG

Interface

Local bus	Data routing
-----------	--------------

Power consumption

Communications power U_L	5 V
Current consumption from U_L	100 mA (typical)/120 mA (maximum)
I/O supply voltage U_{EX} (nominal)	24 V DC
I/O supply voltage U_{EX} (maximum)	28 V DC
Current consumption at U_{EX}	90 mA (typical)/187 mA (maximum)
Total power consumption	1500 mW (typical)/2200 mW (maximum)

Hazardous location ratings

	Output			Input		
Module supply Voltage U_{EX}^1	28 V DC			28 V DC		
Voltage input U_i	0 V DC			0 V DC		
Voltage output U_o	28 V DC			11.76 V DC		
Current output I_o	109 mA			137 mA		
Power output P_o	757 mW			401 mW		
	IIC	IIB	IIA	IIC	IIB	IIA
Capacitance C_o^2	0.083 μ F	0.625 μ F	2.15 μ F	1.5 μ F	9.9 μ F	39 μ F
Inductance L_o^2	1.015 mH	3.045 mH	8.12 mH	1.52 mH	4.56 mH	21.1 mH

¹ $U_{EX} = U_m$ as listed in the SIRA Certification

² The quoted entity parameters of C_o and L_o are applicable for the distributed capacitance and inductance in cable. Where there is circuit capacitance or inductance in the connected equipment (represented by C_i and L_i respectively), then these values shall not exceed 50% of the quoted C_o and L_o .

Supply of the module electronics and I/O through the bus coupler/power terminal

Connection method Potential routing

Digital inputs

Number 4 (can also be configured as outputs)
 Process data update of the channels < 1 ms

Digital inputs (NAMUR)

Number 4 (can also be configured as outputs)
 Input range 0 V to 10 V
 Input resistance 300 k Ω , approximately
 Open circuit response Goes to 0 V

Digital outputs

Number 4 (can also be configured as inputs)
 Process data update of the channels < 1 ms

Electrical isolation/isolation of the voltage areas

Common potentials

The U_{EX} and GND have the same potential. FE is a separate potential area.

Error messages to the higher-level control or computer system

Failure of the internal I/O voltage supply Yes, I/O error message sent to the bus coupler
 Failure of or insufficient communications power U_L Yes, I/O error message sent to the bus coupler
 Peripheral fault/user error Yes, error message via the IN process data

Conformance/approvals

CE	94/9/EC
	EN 60079-0:2009
	EN 60079-11:2007
	EN 60079-15:2010
ATEX	Sira 09ATEX2339X; Ex nA [ia Ga Da] IIC T4 Gc
IECEX	IECEX SIR 10.0033X; Ex nA [ia Ga Da] IIC T4 Gc  II 3(1)GD
UL/cUL	Class I, Div. 2, Groups A, B, C, D
FM	Class I, Div. 2, Groups A-G; Class I, Zone 2 AEx nA [ia] IIC T4

5 Internal circuit diagram

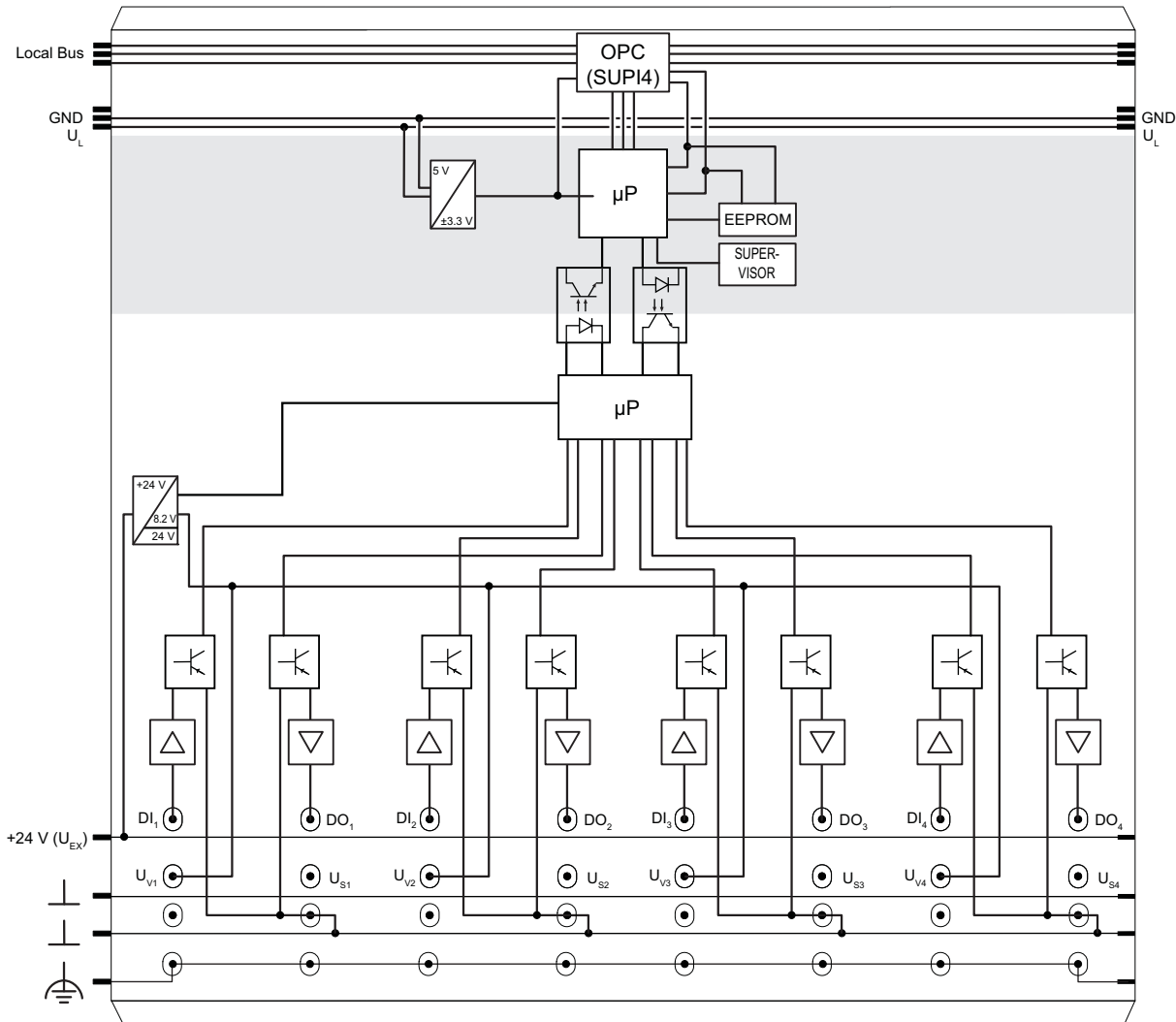









Figure 1 Internal wiring of the terminal points

Key:

	Protocol chip		Transistor
	Power supply unit with electrical isolation		Microprocessor
	Optocoupler		Amplifier
	Electrically erasable programmable read-only memory		Microprocessor monitoring



Other symbols used are explained in the IB IL SYS PRO UM E user manual or in the Inline system manual for your bus system.

6 Electrical isolation

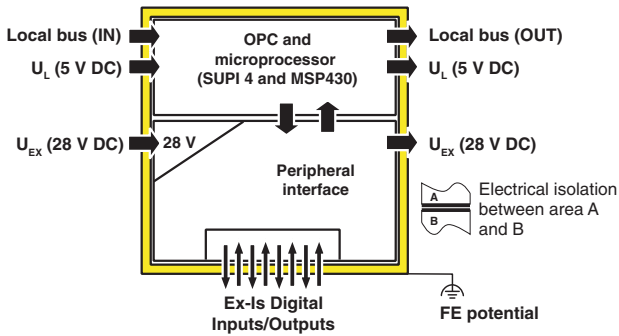

Figure 2 Electrical isolation of the individual function areas

7 Local diagnostic and status indicators and terminal point assignment

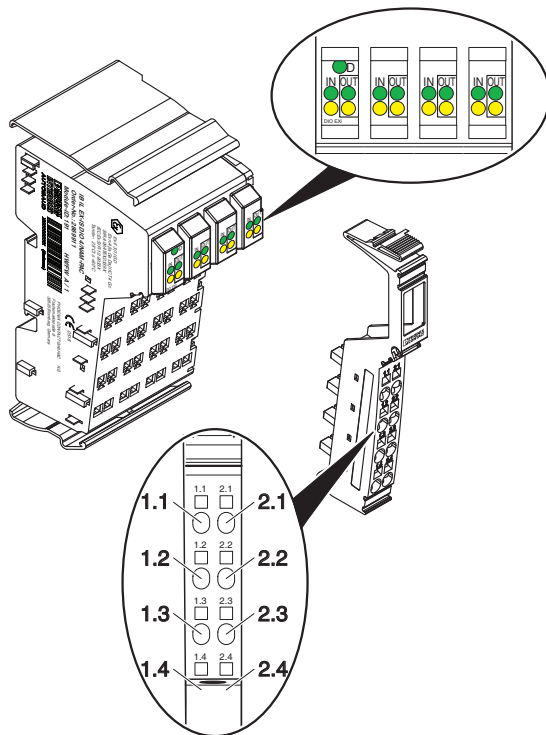

Figure 3 IB IL EX-IS DIO 4/NAM-PAC terminal with an appropriate connector

7.1 Function identification

Color	Meaning
Blue	Digital input
Red	Digital output
Blue (Frame)	Intrinsically safe

7.2 Local diagnostic and status indicators

Des.	Color	Meaning
D	Green	Diagnostics
	0.5 Hz	Local bus stop
	2 Hz	U_{EX} low or off
	4 Hz	Local bus failure
IN	Green (on)	Input on and OK
	Yellow (on)	Status (on = high)
	Red (on)	Broken wire or overload
OUT	Green (on)	Output on and OK
	Yellow (on)	Status (on = high)
	Red (on)	Broken wire or overload

7.3 Terminal point assignment for each connector

Terminal Points	Signal	Assignment
1.1	DI_x	Digital input for channel x
1.2	$U_{Vx} (8.2 V)$	Initiator supply for digital input on channel x
1.3		
1.4		
2.1	DO_x	Digital output for channel x
2.2		
2.3	GND	Ground
2.4		

x = 1 to 4

8 Safety regulations installation notes



For a list of terminals that are approved for the potentially explosive areas of Zone 2, please refer to the AH EN IL EX ZONE 2 application note. Verify use by checking the label on the Inline terminal and the packaging.



WARNING: Explosion hazard

The following conditions must be observed to adhere to the ATEX 94/9/EC directive.

8.1 Special conditions for safe use

The module shall only be supplied from the IB IL EX-IS PWR IN-PAC module.

If the module is installed in a zone 2 hazardous area, it shall be housed in an enclosure that is coded Ex nA, Ex e, Ex d or Ex p. If the module is installed in a zone 22 or 21 hazardous area, it shall be housed in an enclosure that is coded Ex tD or Ex t. For some types of enclosure, additional certification is required to permit the installation of the module within the enclosure. Reference should be made to the enclosure certificate. The installer shall ensure that the maximum ambient temperature of the module, when installed, is not exceeded.

If the module is installed in a non-hazardous area, the enclosure or location shall provide suitable protection. This may be either by the use of an enclosure approved for use in zones 1, 2, 21, or 22 or otherwise meet the following requirements:

- Non-metallic enclosures must be capable of withstanding the thermal endurance requirements of IEC 60079-0 prior to impact and IP54 testing.
- Any enclosure must be capable of withstanding an impact of 7J or the module is otherwise protected from impact.
- The enclosure or location must provide an ingress protection of at least IP54.
- If exposed to sunlight, non-metallic enclosures must be capable of meeting the requirements of IEC 60079-0 clause 26.10 regarding resistance to light.

The installer is responsible for ensuring that the mounting of the module does not reduce the segregation distances between different modules. There shall be a minimum of 6 mm between any intrinsically safe terminals and other conductors or earthed metal, in accordance with IEC 60079-14:2007 clause 12.2.3. In addition, there shall be a minimum of 50 mm between the intrinsically safe terminals of the module and any non-intrinsically safe terminals.

When the module is mounted in a zoned area, live connection and disconnection of the module from the rail is only permitted if the potentially explosive atmosphere is shown to be absent.

Each of the four channels of the IB IL EX-IS DIO 4/NAM-PAC (4x digital in or 4x digital out) shall be treated as separate, intrinsically safe circuits.

The IB IL EX-IS DIO 4/NAM-PAC input and output circuits may not be connected to the same equipment unless the equipment maintains isolation between the circuits.

Each channel shares a common zero volts with the other channels in the IB IL EX-IS DIO 4/NAM-PAC module as well as other IB IL EX-IS DIO 4/NAM-PAC modules and non-isolated IB IL EX-IS...IO... modules connected to the same IB IL EX-IS PWR IN-PAC (power supply) module. If the field devices do not maintain 500 V AC isolation from earth/ground, then all the non-isolated devices from the same IB IL EX-IS PWR IN-PAC module shall be installed in a location (such as the same vessel) where a difference in earth/ground potential is unlikely to occur. If the field devices maintain 500 V AC isolation from earth/ground, there is no such limitation.

The quoted entity parameters of C_0 and L_0 are applicable for the distributed capacitance and inductance in cable. Where there is circuit capacitance or inductance in the connected equipment (represented by C_i and L_c respectively), these values shall not exceed 50% of the quoted C_0 and L_0 .

8.2 Safety instructions



WARNING:

The safety instructions must be read and understood before installing and using this equipment.

Installation instructions

The device is an associated equipment of the “intrinsically safe” protection type and suitable for installation in zone 2.

Follow the installation instructions.

Installation, operation and maintenance may only be carried out by qualified personnel.

Always remove power from Inline station before installing or removing any Inline terminal.

Comply with the valid safety regulations (including national safety regulations) for the installation and operation, accident prevention regulations, and the general rules and regulations pertaining to technology. The safety relevant data may be derived from the operating instructions and the cer-

tificates (EC type examination certificate, possibly additional ratings).



WARNING:

Substitution of components will impair intrinsic safety.



WARNING:

To prevent ignition of flammable or combustible atmospheres, disconnect power before servicing.

Access to the circuits or substitution of components within the device will impair intrinsic safety and is prohibited. Do not repair the device yourself, but replace it with an equivalent device. Repairs may only be carried out by the manufacturer.

The IP20 degree of protection (IEC 60529/EN 60529) is intended for a clean and dry environment. Do not expose the device to any mechanical or thermal influences that exceed the limits described.

Intrinsic safety

When carrying out measurements on the intrinsically safe side, it is imperative that you observe the relevant regulations regarding connecting intrinsically safe electrical equipment. Only use equipment approved for intrinsically safe circuits.

If the device was used in circuits that are not intrinsically safe, it is forbidden to use it again in intrinsically safe circuits. Label the device clearly as being not intrinsically safe.

Installation in zone 2

Observe the specified conditions for use in potentially explosive areas! Use a suitable housing of the minimum protection IP54 for the installation. Within this context observe the requirements of IEC 60079-14/EN 60079-14, i.e., steel housing with a wall thickness of 3 mm.

Do not connect any live cables/lines within the potentially explosive area.

Only use IB IL EX-IS... modules of category 3G (ATEX 94/9EG).

Potentially dust-explosive areas

The device is not designed for use in environments capable of dust explosions.

Only make the connection to the intrinsically safe circuit in potentially dust-explosive areas of zones 20, 21 and 22 if the equipment connected to this circuit is certified for this zone (e.g., category 1D, 2D or 3D).

8.3 FM compliance

In addition to the previous statements, FM compliance requires that the module is mounted in an enclosure that meets the requirements of ANSI/ISA 601010 and is installed according to the mounting, spacing and segregation requirements of the enclosure for the ultimate application.

9 Installation instructions

Always install the IB IL EX-IS... at the end of an Inline station. If additional power is required, a new node must be installed. Intrinsically safe wiring must be installed separately from non-intrinsically safe wiring (can't be mixed within a wire channel). A new IS power supply is required if the red LED shows overloading.

9.1 Overview

Inline intrinsically safe IO terminals can be installed in a standard Inline station and are supported by all major industrial networks. Basic and intrinsically safe wiring practices need to be followed by the following concept.

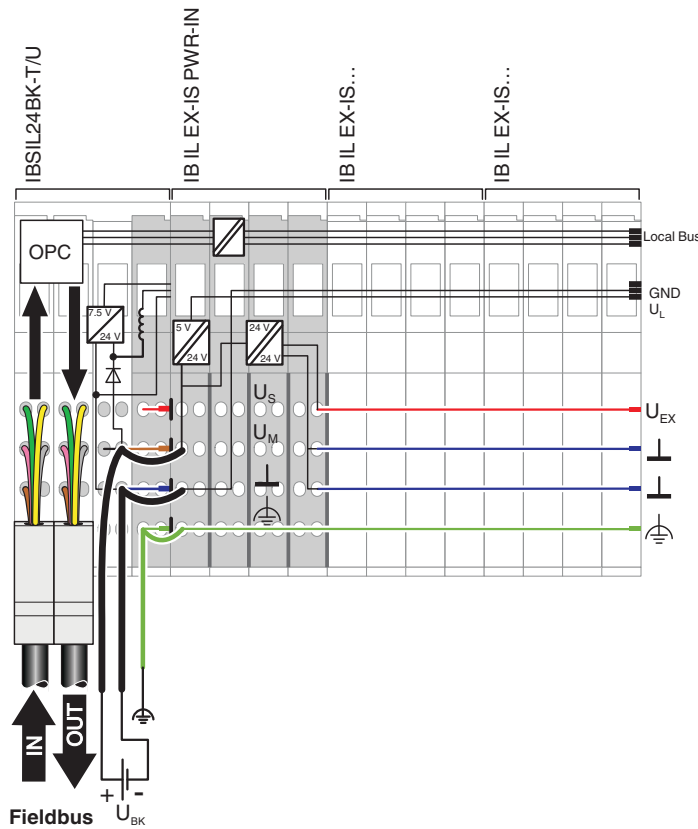

Figure 4 Intrinsically safe Inline terminals power supply

A new IB IL EX-IS PWR IN-PAC supply is required if the red LED on the power supply shows overloading. If additional power is required, a new node must be installed.

9.2 Power budget

The IB IL EX-IS PWR IN-PAC provides power to the IB IL EX-IS DIO 4/NAM-PAC terminal in two ways:

- 1000 mA is available for the logic functions (U_L).
- 1000 mA is available for the I/O functions (U_{EX}).

The number of terminals that can be powered by the IB IL EX-IS PWR IN-PAC varies according to the type of terminal and the number and type of I/O connections.

Based on the logic functions, the maximum number of terminals that can be connected is **10**.

The IB IL EX-IS DIO 4/NAM-PAC terminal draws different power depending on the type of connection. To determine the number of I/O points that can be connected, refer to Table 1.

Table 1 U_{EX} Current Draw

	IB IL EX-IS DIO 4/NAM-PAC
Terminal overhead	20 mA
Output channel	45 mA
Input channel	10 mA

To calculate the power requirements of a system, list the number and type of each connected point. From this list, determine the number and type of terminals required. Multiply the number of each I/O point by the appropriate current draw listed in Table 1.

Add the terminal overhead current for each terminal used. The sum of the I/O point current draw and the terminal overhead current draw determines the total current draw from the IB IL EX-IS PWR IN-PAC. The maximum current draw is 1000 mA.



Additional information and examples about power budget calculation can be found on the Power Supply data sheet.

10 Connection examples

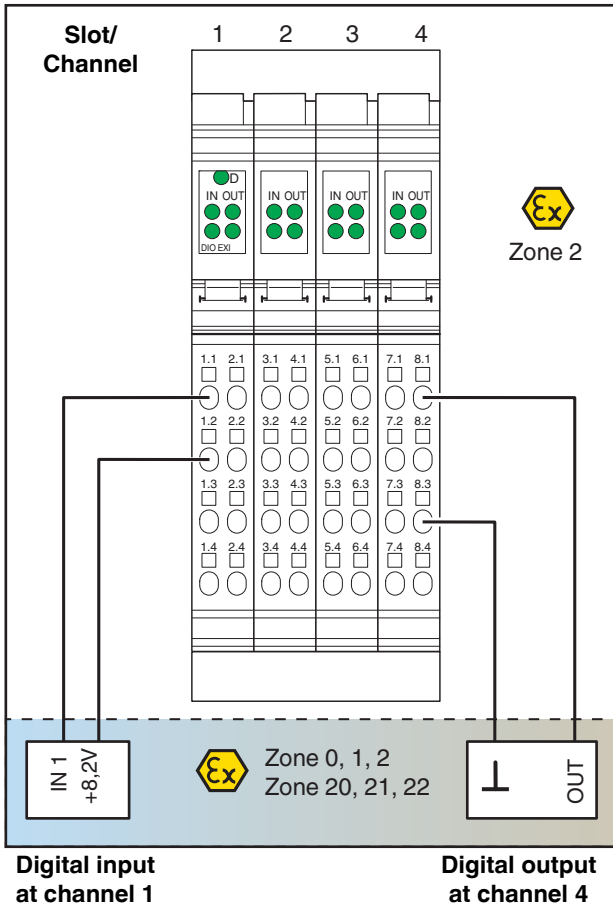

Figure 5 Connection overview

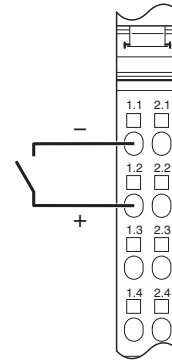

Figure 7 Dry-contact input example

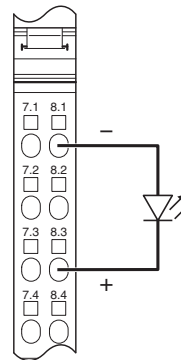

Figure 8 Digital output example

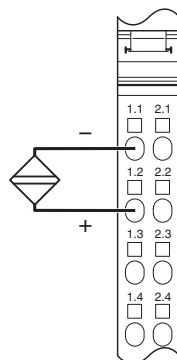

Figure 6 NAMUR input example

11 Programming data/configuration data

11.1 INTERBUS

ID code	0xBF _{hex} (191 _{dec})
Length code	01 _{hex}
Input address area	1 words
Output address area	1 words
Parameter channel (PCP)	0
Register length (bus)	1 words

11.2 Other bus systems



For the programming data/configuration data of other bus systems, please refer to the corresponding electronic device data sheet (e.g., GSD, EDS).

12 Configuration and read/write via process data

Below are the details of the process data word.

12.1 Output

The process data word is used for configuring the channels and writing output data.

		OUT1																
		Byte 1							Byte 0									
Bit		15	14	13	12	11	10	9	8	7	6	5	4	3	2	1	0	
Assignment		Command 0x5				Out ch 4	Out ch 3	Out ch 2	Out ch 1	Config Ch 4	Config Ch 3	Config Ch 2	Config Ch 1					

Placing command code 0x5 in bits 12 to 15 allows configuration of channels 1 through 4. Command code 0x5 is not required to set output bits 8 to 11, but can be used. Once configured, however, it is suggested that output bits 15 to 12 are set to 0x0 to avoid unintentional configuration of the module.

The default refresh rate is 10 ms.

Parameters for configuration

Channel 1 to channel 4, bits 0 to 7

Code (bin)	Format
00	Disable channel
01	Input
10	Output
11	Standard digital input (non-NAMUR)

Parameters for digital output

Channel 1 to channel 4, bits 8 to 11	
0	Logic low
1	Logic high

12.2 Input data/diagnostics

Reading back the input and diagnostic information.

		IN1															
		Byte 1								Byte 0							
Bit		15	14	13	12	11	10	9	8	7	6	5	4	3	2	1	0
Assignment		Command Mirror 0x5				In ch 4	In ch 3	In ch 2	In ch 1	Diag Ch 4		Diag Ch 3		Diag Ch 2		Diag Ch 1	

Input data (bits 8-11) for channels are valid only if the corresponding channels are configured for input.

For all unconfigured channels, the diagnostic info will return "Invalid Level".

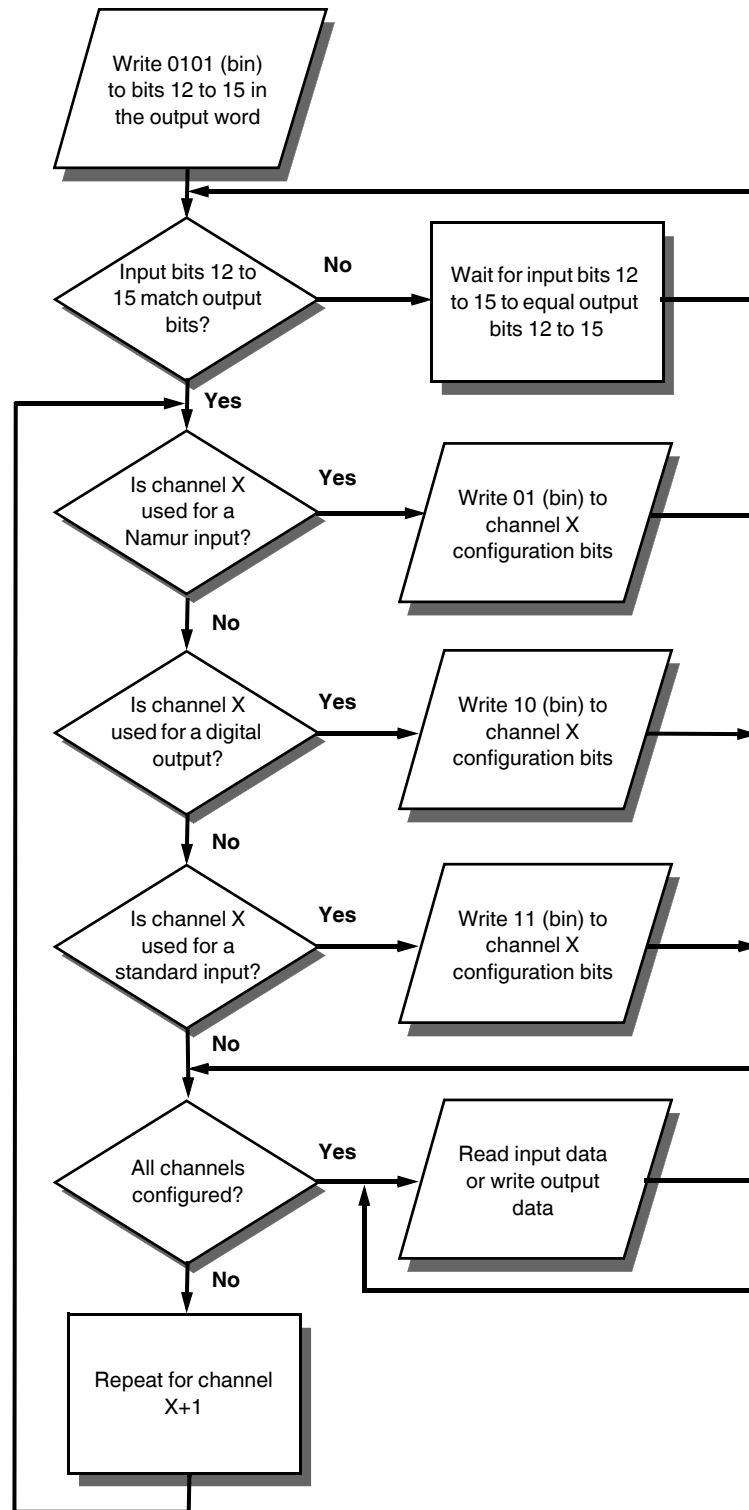

Figure 9 Diagnostic flowchart

Diagnostics

Channel 1 to channel 4, bits 0 to 7 (applies to NAMUR sensors only).

Code (bin)	Format
00	No error
01	Short
10	Open
11	Invalid level