



RoHS Compliant

SPECIFICATION FOR APPROVAL

TO : _____

PAGE : 2/4

CUSTOMER PART NO	REV. 00	DELTA PART NO. DSP-16065	ISSUE DATE MAY.20.2015	TEMP(°C) 25
PART NAME Solenoid Pump		DELTA REV. -	USED ON	HUM (%) 58 RH

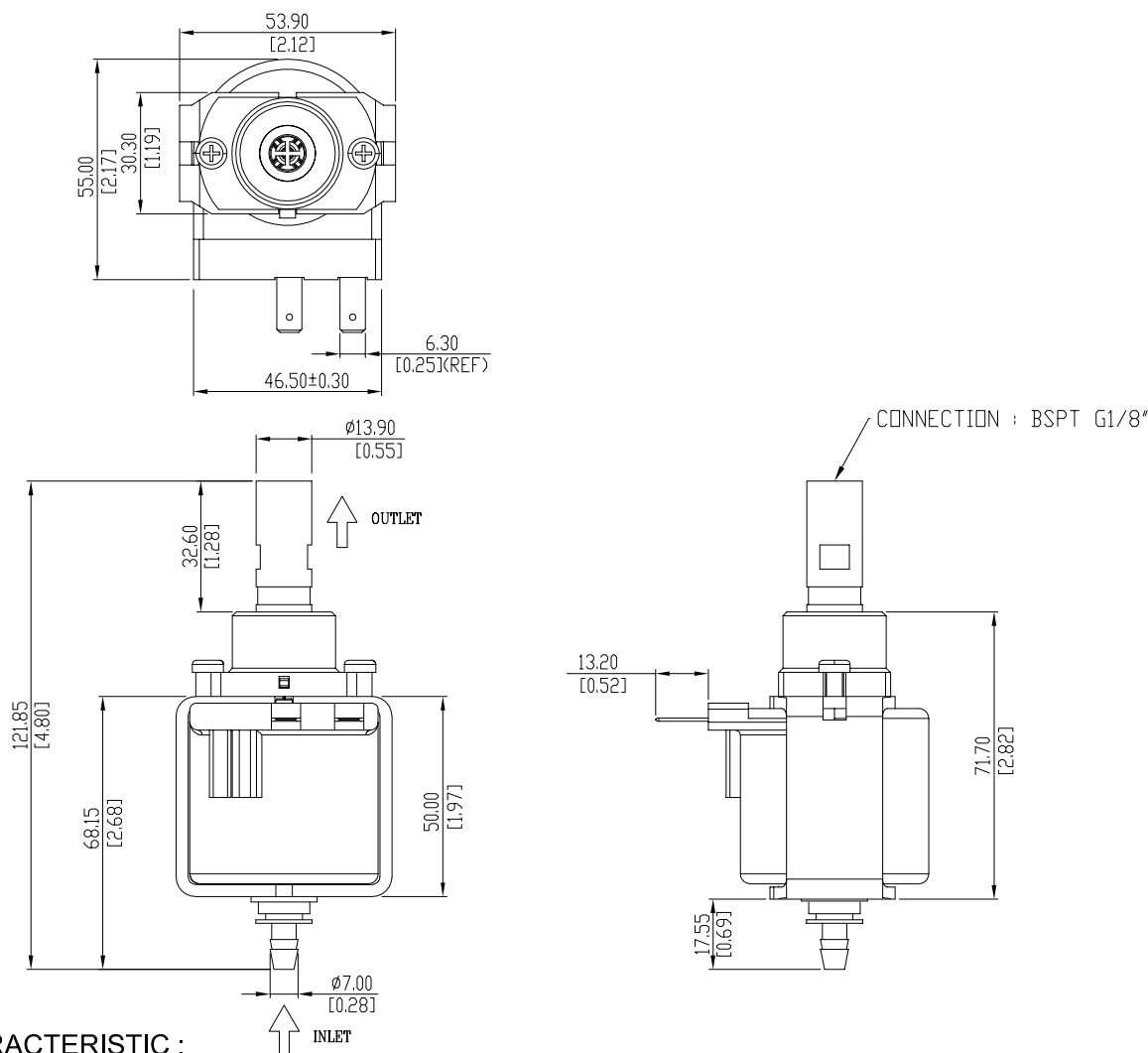
1. MECHANICAL DIMENSIONS : ($\frac{\text{mm}}{\text{inch}}$)

2. CHARACTERISTIC :

- 2-1. OPERATING VOLTAGE: 230Vac / 50Hz
- 2-2. POWER CONSUMPTION: 48W
- 2-3. OUTLET : BSPT 1/8"
- 2-4. FLOW RATE MAX : 650 c.c./min
- 2-5. FLOW RATE TOLERANCE : ±15%
- 2-6. PRESSURE MAX : 230 psi (16 bar)
- 2-7. WATER TEMPERATURE : 20 °C
- 2-8. WORKING CYCLE : 2 min ON / 1 min OFF
- 2-9. INTEGRATED DIODE
- 2-10. TEMPERATURE CLASS : F (155°C)
- 2-11. MAX. ON TIME : 13 min



RoHS Compliant

SPECIFICATION FOR APPROVAL

TO : _

PAGE : 3/4

CUSTOMER PART NO	REV. 00	DELTA PART NO. DSP-16065	ISSUE DATE MAY.20.2015	TEMP(°C) 25
PART NAME Solenoid Pump		DELTA REV. -	USED ON	HUM (%) 58 RH

2. P-Q CURVE :

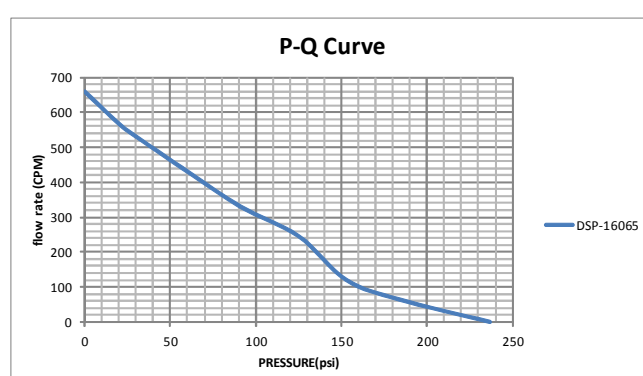
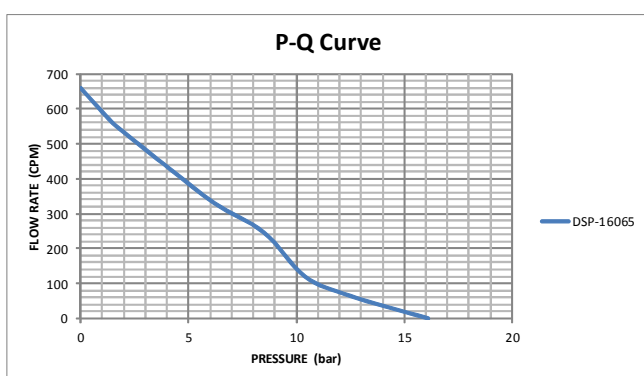

3. NOISE TEST : 51.1 dBA (at p=0 Bar/ 100cm)

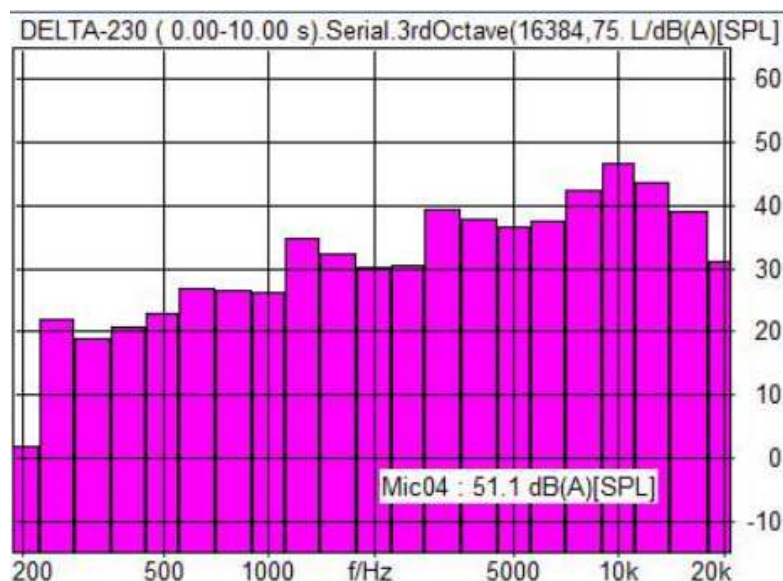



RoHS Compliant

SPECIFICATION FOR APPROVAL

TO : _

PAGE : 4/4

CUSTOMER PART NO	REV. 00	DELTA PART NO. DSP-16065	ISSUE DATE MAY.20.2015	TEMP(°C) 25
PART NAME Solenoid Pump		DELTA REV. -	USED ON	HUM (%) 58 RH

4. EMC TEST :

3-1. BACKGROUND

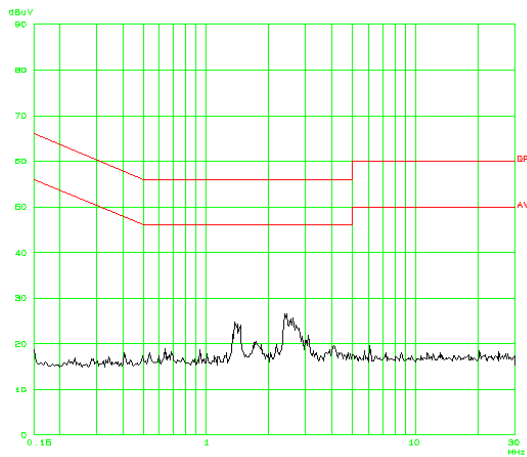

3-2. STANDBY

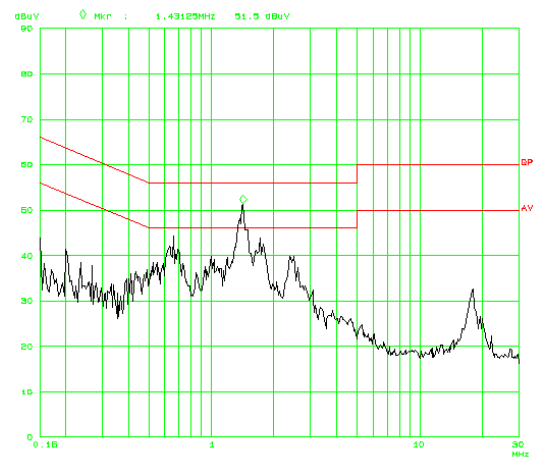

1.43125 MHz QP 49.7dB AV 43dB

3-3. OPERATION

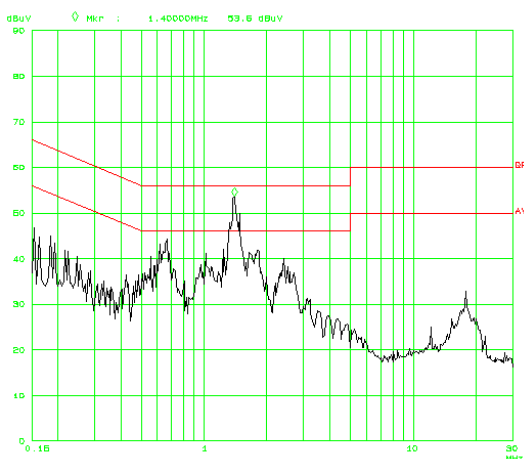

1.4 MHz QP 49dB AV 42.5dB