

PART NAME

NEMA 4X ENCLOSURE

PART No.

PN-1328, PN-1328-C AND PN-1328-DG

REV. DATE

11-17-08

INDUSTRY STANDARDS:

POLYCARBONATE (LIGHT GRAY AND CLEAR)
 UL94-HB FLAMMABILITY RATING (UL FILE #E41613)
 UV STABILIZED
 SERVICE TEMPERATURE RANGE: -40°C TO +120°C

ABS (DARK GRAY)
 UL94-HB FLAMMABILITY RATING (UL FILE #E56070)
 SERVICE TEMPERATURE RANGE: -40°C TO +80°C

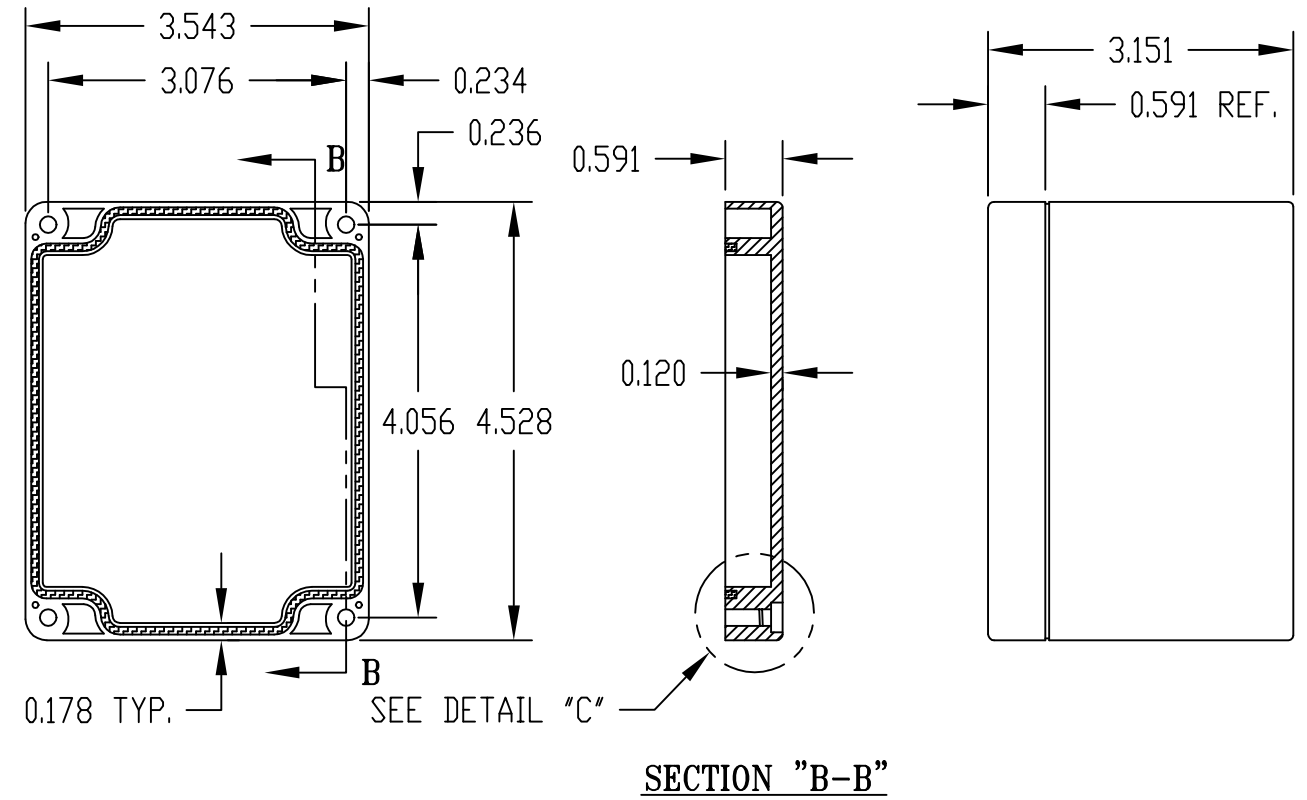
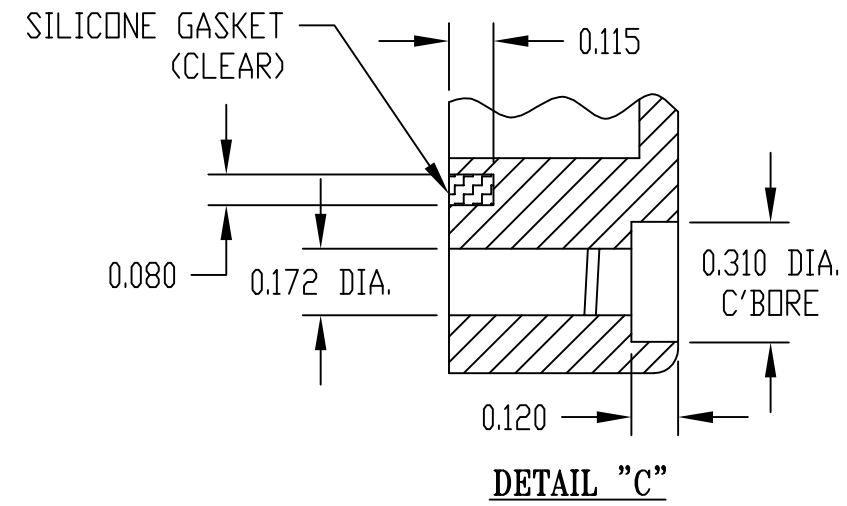
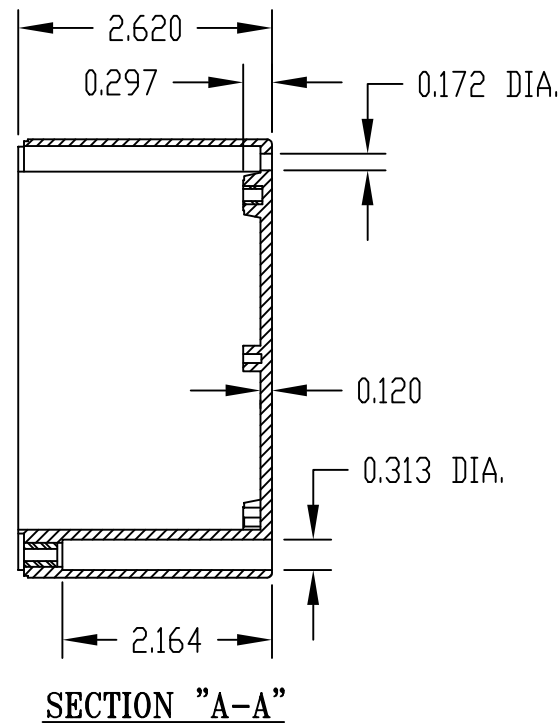
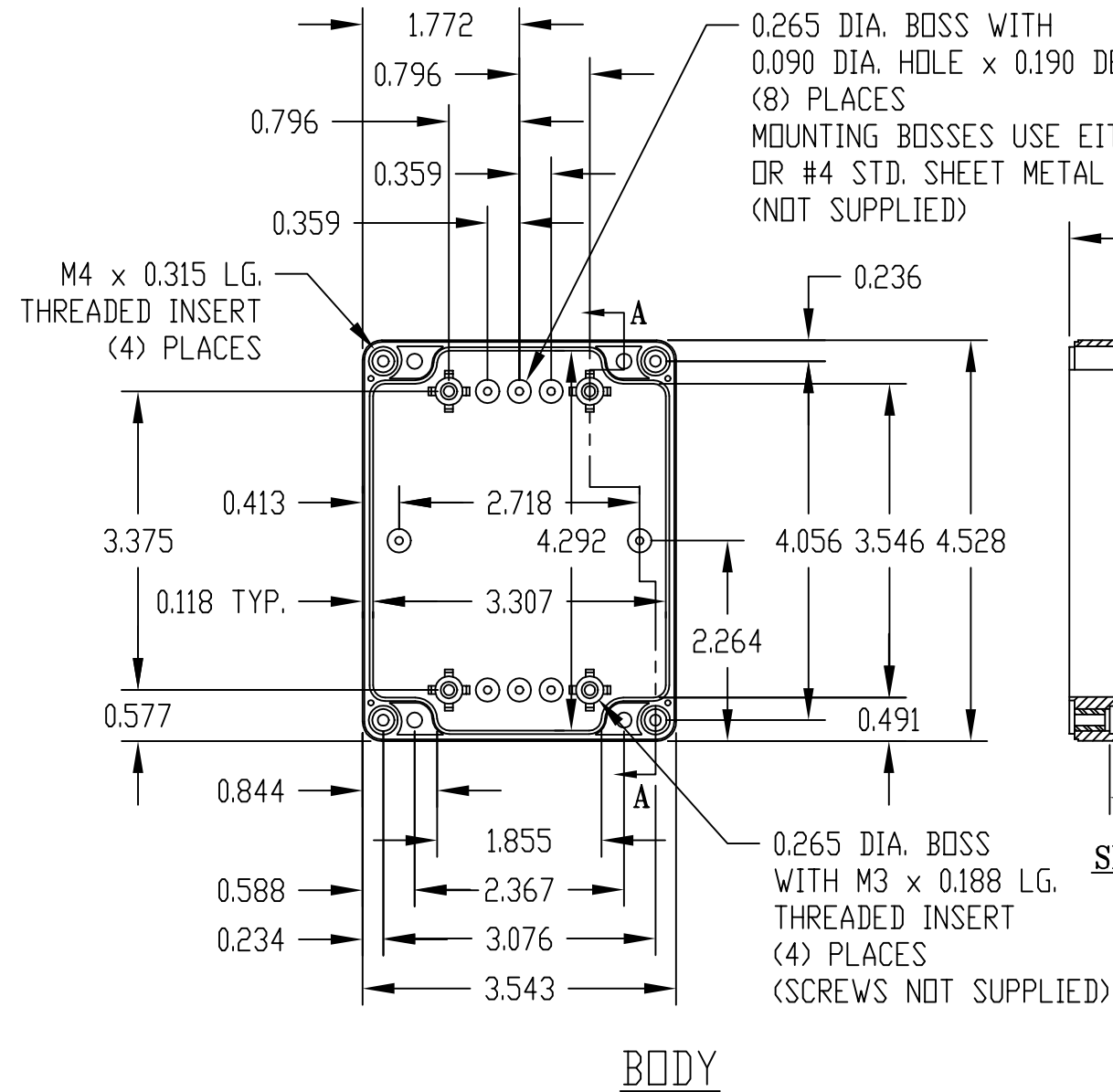

NOTE: ALL DIMENSIONS HAVE ±0.015 TOLERANCE UNLESS OTHERWISE SPECIFIED.

PART NUMBER	MATERIAL		FINISH		HARDWARE KIT
	BODY	COVER	BODY	COVER	
PN-1328	POLYCARBONATE		LIGHT GRAY		KIT CONTAINS (4) M4 x 20mm (0.787") LG. SCREWS FOR ASSEMBLY
PN-1328-C	POLYCARBONATE		LIGHT GRAY	CLEAR	
PN-1328-DG	HIGH-IMPACT ABS		DARK GRAY		