

# Polar™ Power MOSFET HiPerFET™

N-Channel Enhancement Mode  
Avalanche Rated  
Fast Intrinsic Diode

**IXFH12N120P**  
**IXFV12N120P**  
**IXFV12N120PS**

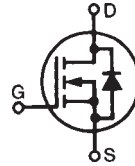

**V<sub>DSS</sub> = 1200V**  
**I<sub>D25</sub> = 12A**  
**R<sub>DS(on)</sub> ≤ 1.35Ω**  
**t<sub>rr</sub> ≤ 300ns**

Symbol	Test Conditions	Maximum Ratings	
V <sub>DSS</sub>	T <sub>J</sub> = 25°C to 150°C	1200	V
V <sub>DGR</sub>	T <sub>J</sub> = 25°C to 150°C, R <sub>GS</sub> = 1MΩ	1200	V
V <sub>GSS</sub>	Continuous	± 30	V
V <sub>GSM</sub>	Transient	± 40	V
I <sub>D25</sub>	T <sub>C</sub> = 25°C	12	A
I <sub>DM</sub>	T <sub>C</sub> = 25°C, pulse width limited by T <sub>JM</sub>	30	A
I <sub>A</sub>	T <sub>C</sub> = 25°C	6	A
E <sub>AS</sub>	T <sub>C</sub> = 25°C	500	mJ
dV/dt	I <sub>S</sub> ≤ I <sub>DM</sub> , V <sub>DD</sub> ≤ V <sub>DSS</sub> , T <sub>J</sub> ≤ 150°C	15	V/ns
P <sub>D</sub>	T <sub>C</sub> = 25°C	543	W
T <sub>J</sub>		-55 ... +150	°C
T <sub>JM</sub>		150	°C
T <sub>stg</sub>		-55 ... +150	°C
T <sub>L</sub>	Maximum lead temperature for soldering	300	°C
T <sub>SOLD</sub>	Plastic body for 10s	260	°C
M <sub>d</sub>	Mounting torque (TO-247)	1.13/10	Nm/lb.in.
F <sub>C</sub>	Mounting force (PLUS 220)	11..65 / 2.5..14.6	N/lb.
Weight	TO-247	6	g
	PLUS 220 types	4	g

Symbol	Test Conditions (T <sub>J</sub> = 25°C, unless otherwise specified)	Characteristic Values		
		Min.	Typ.	Max.
BV <sub>DSS</sub>	V <sub>GS</sub> = 0V, I <sub>D</sub> = 1mA	1200		V
V <sub>GS(th)</sub>	V <sub>DS</sub> = V <sub>GS</sub> , I <sub>D</sub> = 1mA	3.5		6.5 V
I <sub>GSS</sub>	V <sub>GS</sub> = ± 30V, V <sub>DS</sub> = 0V			± 100 nA
I <sub>DSS</sub>	V <sub>DS</sub> = V <sub>DSS</sub> V <sub>GS</sub> = 0V T <sub>J</sub> = 125°C			25 μA 2 mA
R <sub>DS(on)</sub>	V <sub>GS</sub> = 10V, I <sub>D</sub> = 0.5 • I <sub>D25</sub> , Note 1	1.15	1.35	Ω

PLUS220 (IXFV)

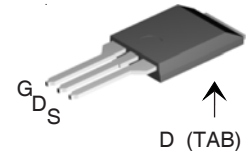

PLUS220SMD (IXFV\_S)

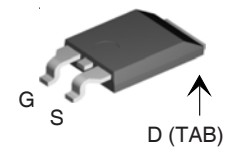

TO-247 (IXFH)

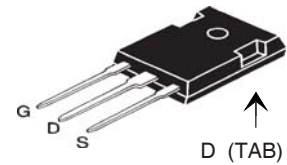

G = Gate    D = Drain  
S = Source    TAB = Drain

## Features

- International standard packages
- Fast recovery diode
- Unclamped Inductive Switching (UIS) rated
- Low package inductance
  - easy to drive and to protect

## Advantages

- Easy to mount
- Space savings
- High power density

## Applications:

- High Voltage Switched-mode and resonant-mode power supplies
- High Voltage Pulse Power Applications
- High Voltage Discharge circuits in Lasers Pulsers, Spark Igniters, RF Generators
- High Voltage DC-DC converters
- High Voltage DC-AC inverters

Symbol	Test Conditions ( $T_J = 25^\circ\text{C}$ unless otherwise specified)	Characteristic Values		
		Min.	Typ.	Max.
$g_{fs}$	$V_{DS} = 20\text{V}, I_D = 0.5 \cdot I_{D25}$ , Note 1	5	9	S
$C_{iss}$	$V_{GS} = 0\text{V}, V_{DS} = 25\text{V}, f = 1\text{MHz}$		5400	pF
$C_{oss}$			290	pF
$C_{rss}$			40	pF
$R_{Gi}$	Gate input resistance		1.5	$\Omega$
$t_{d(on)}$	<b>Resistive Switching Times</b> $V_{GS} = 10\text{V}, V_{DS} = 0.5 \cdot V_{DSS}, I_D = 0.5 \cdot I_{D25}$ $R_G = 2\Omega$ (External)		34	ns
$t_r$			25	ns
$t_{d(off)}$			62	ns
$t_f$			34	ns
$Q_{g(on)}$	$V_{GS} = 10\text{V}, V_{DS} = 0.5 \cdot V_{DSS}, I_D = 0.5 \cdot I_{D25}$		103	nC
$Q_{gs}$			29	nC
$Q_{gd}$			41	nC
$R_{thJC}$				0.23 $^\circ\text{C/W}$
$R_{thCS}$	(TO-247, PLUS 220)	0.21		$^\circ\text{C/W}$

Symbol	Test Conditions ( $T_J = 25^\circ\text{C}$ unless otherwise specified)	Characteristic Values		
		Min.	Typ.	Max.
$I_s$	$V_{GS} = 0\text{V}$			12 A
$I_{SM}$	Repetitive, pulse width limited by $T_{JM}$			48 A
$V_{SD}$	$I_F = I_s, V_{GS} = 0\text{V}$ , Note 1			1.5 V
$t_{rr}$	$I_F = 6\text{A}, -di/dt = 100\text{A}/\mu\text{s}$			300 ns
$Q_{RM}$			0.5	$\mu\text{C}$
$I_{RM}$	$V_R = 100\text{V}, V_{GS} = 0\text{V}$		6	A

Note 1: Pulse test,  $t \leq 300\mu\text{s}$ ; duty cycle,  $d \leq 2\%$ .

**PLUS220SMD (IXFV\_S) Outline**

SYM	INCHES		MILLIMETER	
	MIN	MAX	MIN	MAX
A	.169	.185	4.30	4.70
A1	.028	.035	0.70	0.90
A2	.098	.118	2.50	3.00
A3	.000	.010	0.00	0.25
b	.035	.047	0.90	1.20
b1	.080	.095	2.03	2.41
b2	.054	.064	1.37	1.63
c	.028	.035	0.70	0.90
D	.551	.591	14.00	15.00
D1	.512	.539	13.00	13.70
E	.394	.433	10.00	11.00
E1	.331	.346	8.40	8.80
e	.200BSC		5.08 BSC	
L	.209	.228	5.30	5.80
L1	.118	.138	3.00	3.50
L2	.035	.051	0.90	1.30
L3	.047	.059	1.20	1.50
L4	.039	.059	1.00	1.50

1. GATE  
2. DRAIN (COLLECTOR)  
3. SOURCE (EMITTER)  
4. DRAIN (COLLECTOR)

**PLUS220 (IXFV) Outline**

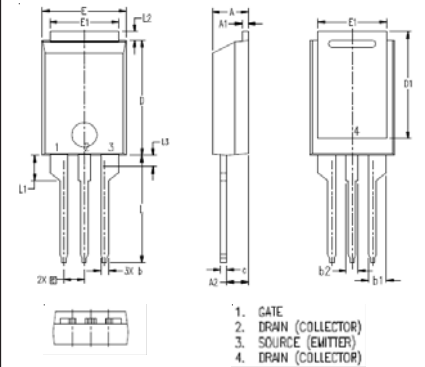

SYM	INCHES		MILLIMETER	
	MIN	MAX	MIN	MAX
A	.169	.185	4.30	4.70
A1	.028	.035	0.70	0.90
A2	.098	.118	2.50	3.00
b	.035	.047	0.90	1.20
b1	.080	.095	2.03	2.41
b2	.054	.064	1.37	1.63
c	.028	.035	0.70	0.90
D	.551	.591	14.00	15.00
D1	.512	.539	13.00	13.70
E	.394	.433	10.00	11.00
E1	.331	.346	8.40	8.80
e	.100BSC		2.54 BSC	
L	.512	.551	13.00	14.00
L1	.118	.138	3.00	3.50
L2	.035	.051	0.90	1.30
L3	.047	.059	1.20	1.50

**TO-247 (IXFH) Outline**

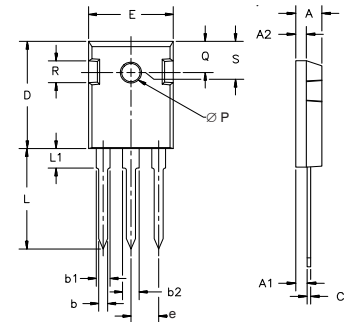

Dim.	Millimeter		Inches	
	Min.	Max.	Min.	Max.
A	4.7	5.3	.185	.209
A <sub>1</sub>	2.2	2.54	.087	.102
A <sub>2</sub>	2.2	2.6	.059	.098
b	1.0	1.4	.040	.055
b <sub>1</sub>	1.65	2.13	.065	.084
b <sub>2</sub>	2.87	3.12	.113	.123
C	.4	.8	.016	.031
D	20.80	21.46	.819	.845
E	15.75	16.26	.610	.640
e	5.20	5.72	0.205	0.225
L	19.81	20.32	.780	.800
L1		4.50		.177
∅P	3.55	3.65	.140	.144
Q	5.89	6.40	0.232	0.252
R	4.32	5.49	.170	.216
S	6.15	BSC	242	BSC

IXYS reserves the right to change limits, test conditions, and dimensions.

IXYS MOSFETs and IGBTs are covered by one or more of the following U.S. patents:	4,835,592	4,931,844	5,049,961	5,237,481	6,162,665	6,404,065 B1	6,683,344	6,727,585	7,005,734 B2	7,157,338 B2
	4,850,072	5,017,508	5,063,307	5,381,025	6,259,123 B1	6,534,343	6,710,405 B2	6,759,692	7,063,975 B2	
	4,881,106	5,034,796	5,187,117	5,486,715	6,306,728 B1	6,583,505	6,710,463	6,771,478 B2	7,071,537	

**Fig. 1. Output Characteristics @ 25°C**

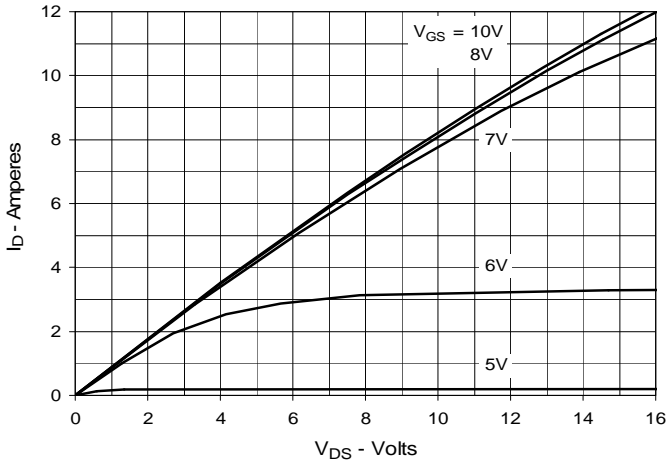

**Fig. 2. Extended Output Characteristics @ 25°C**

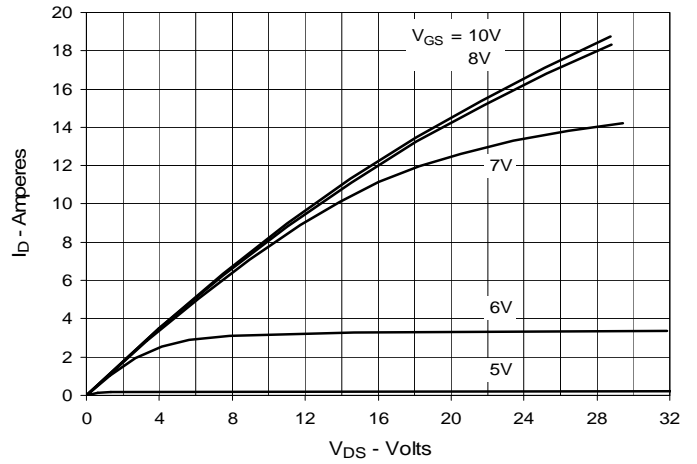

**Fig. 3. Output Characteristics @ 125°C**

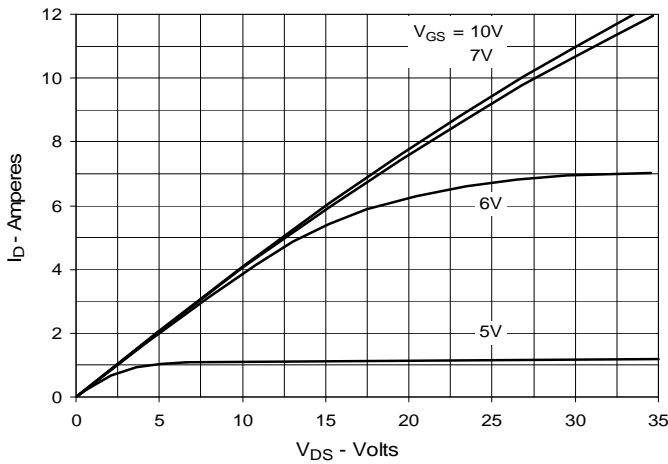

**Fig. 4.  $R_{DS(on)}$  Normalized to  $I_D = 6A$  Value vs. Junction Temperature**

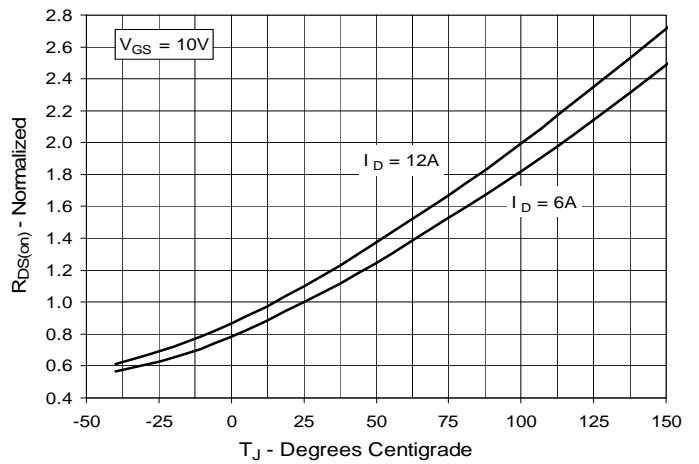

**Fig. 5.  $R_{DS(on)}$  Normalized to  $I_D = 6A$  Value vs. Drain Current**

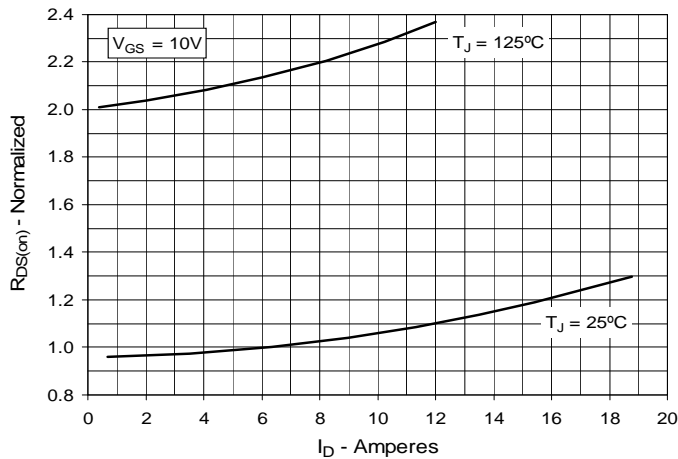

**Fig. 6. Maximum Drain Current vs. Case Temperature**

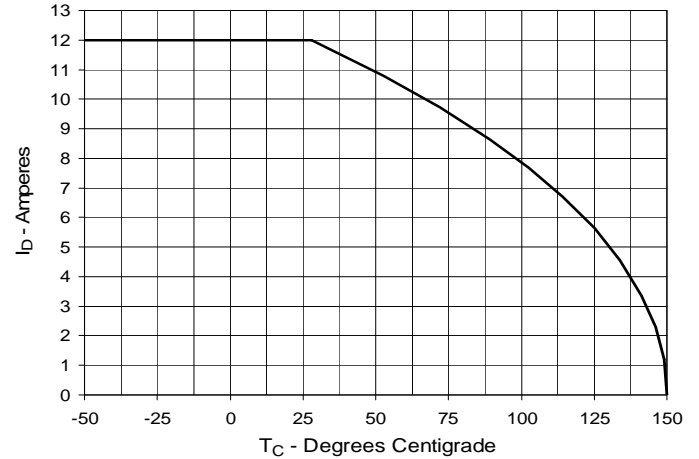

**Fig. 7. Input Admittance**

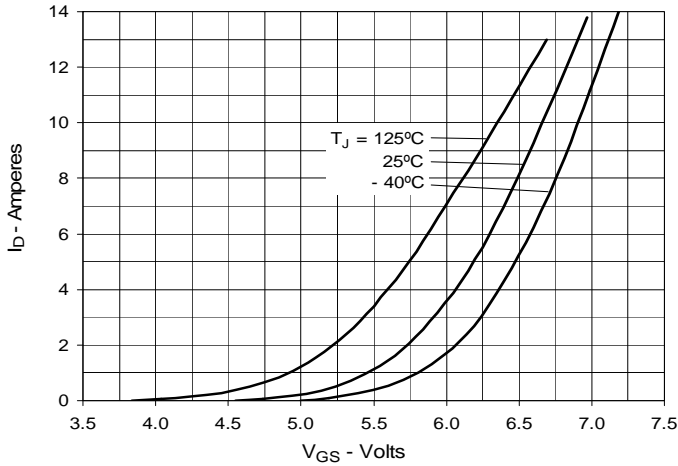

**Fig. 8. Transconductance**

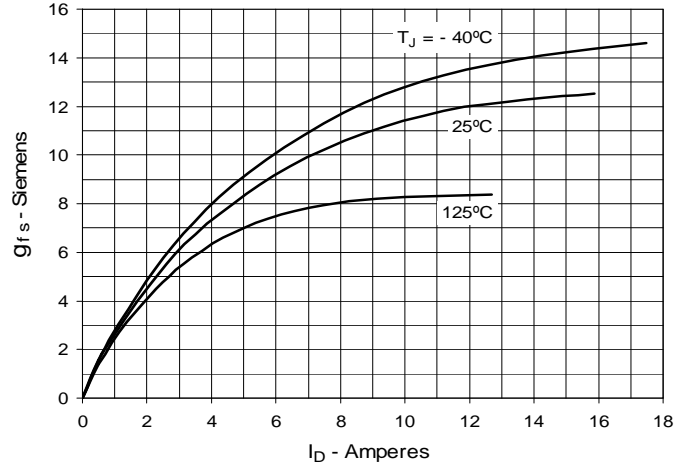

**Fig. 9. Forward Voltage Drop of Intrinsic Diode**

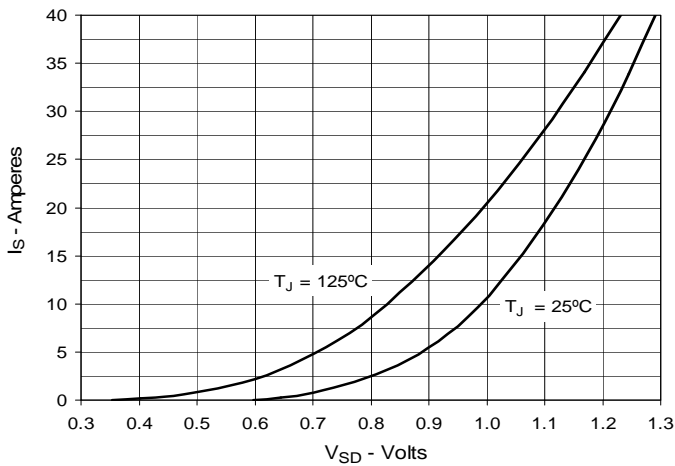

**Fig. 10. Gate Charge**

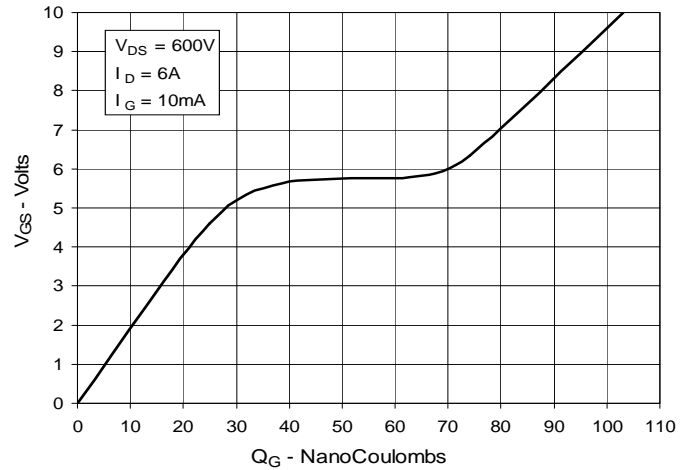

**Fig. 11. Capacitance**

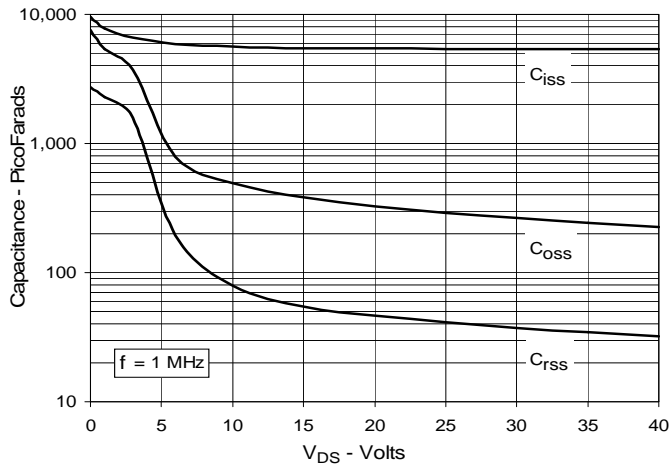

**Fig. 12. Maximum Transient Thermal Impedance**

