



Typical Applications

The HMC446 / HMC446E is ideal for:

- ISM/Cellular Portables/Handsets
- Automotive Telematic Applications
- Mobile Radio

Features

- Low Insertion Loss: 0.6 dB
- High IIP3: +65 dBm
- High Input P0.1 dB: +40 dBm Tx
- Positive Control: 0/+5V to 0/+8V
- Ultra Small Package: SOT26

Functional Diagram

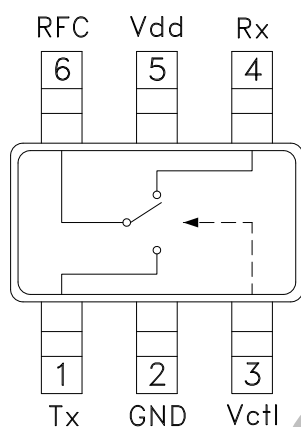

General Description

The HMC446 & HMC446E are low-cost SPDT switches in 6-lead SOT26 packages for use in transmit-receive applications which require very low distortion at high signal power levels, up to 10 watts. The device can control signals from 824 - 894 MHz* and is especially suited for cellular booster and automotive telematic applications. The design provides exceptional P0.1 dB of +40 dBm and +65 dBm IIP3 on the Transmit (Tx) port. The Tx port is a reflective open when "Off" while the Rx port is a reflective short when "Off". On-chip circuitry allows single positive supply operation at very low DC current with a single control input (Vctl).

Electrical Specifications, $T_A = +25^\circ\text{C}$, $V_{ctl} = 0/+8\text{ Vdc}$, 50 Ohm System

Parameter		Frequency*	Min.	Typ.	Max.	Units
Insertion Loss	Tx - RFC	824 - 849 MHz		0.6	0.9	dB
	RFC - Rx	824 - 894 MHz		0.6	1.0	dB
Isolation	Tx - RFC	824 - 849 MHz	18	22		dB
	RFC - Rx	824 - 894 MHz	29	35		dB
Return Loss	Tx - RFC	824 - 849 MHz		13		dB
	RFC - Rx	824 - 894 MHz		17		dB
Input Power for 0.1 dB Compression	Tx - RFC	824 - 849 MHz	38	40		dBm
	RFC - Rx	824 - 894 MHz	28	30		dBm
Input Third Order Intercept (Two-tone input power = +19 dBm each tone)	Tx - RFC	824 - 849 MHz		65		dBm
	RFC - Rx	824 - 894 MHz		52		dBm
Switching Characteristics		824 - 894 MHz				
	tRISE, tFALL (10/90% RF) tON, tOFF (50% CTL to 10/90% RF)			4 90		ns ns

* External component values can be adjusted to enable HMC446 to operate in other frequency bands. Contact HMC with your specific requirement.



Insertion Loss vs. Temperature, Tx

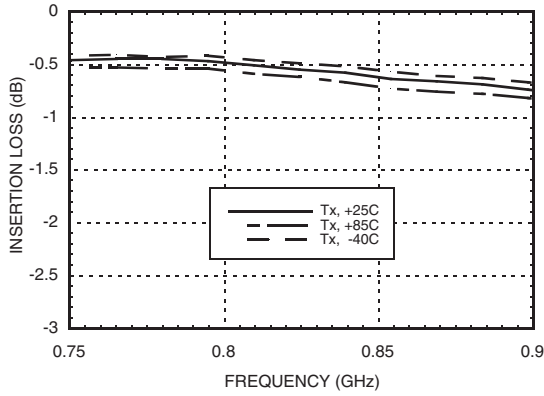

Insertion Loss vs. Temperature, Rx

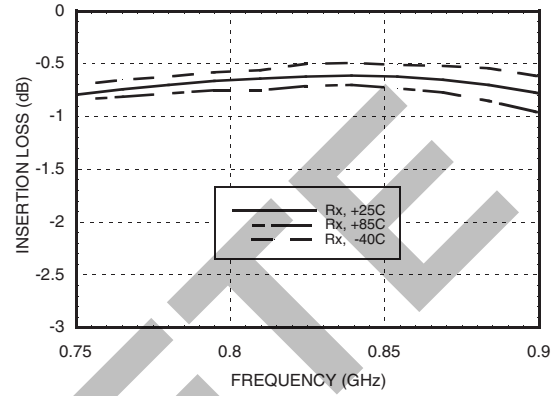

Isolation

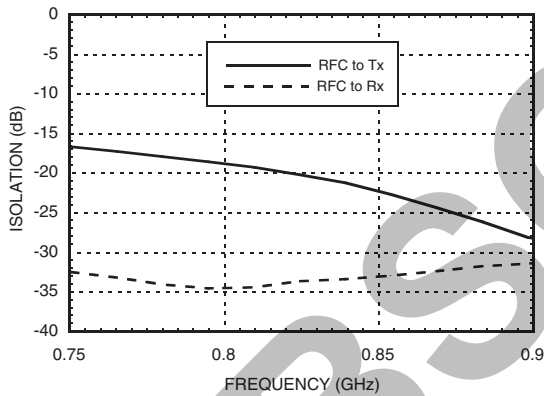

Return Loss

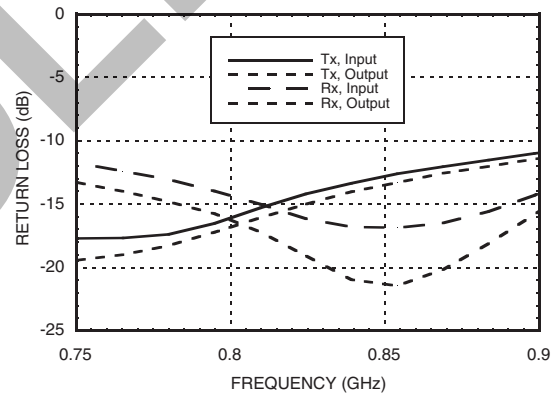

**Input Power Compression
@ 849 MHz, Vdd = 8.0V**

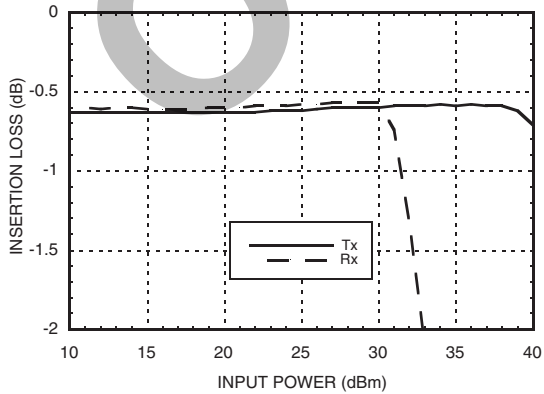

**Input Power Compression
@ 849 MHz, Vdd = 5.0V**

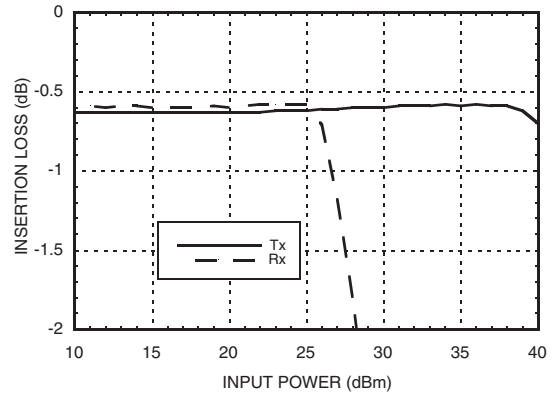

Information furnished by Analog Devices is believed to be accurate and reliable. However, no responsibility is assumed by Analog Devices for its use, nor for any infringements of patents or other rights of third parties that may result from its use. Specifications subject to change without notice. No license is granted by implication or otherwise under any patent or patent rights of Analog Devices. Trademarks and registered trademarks are the property of their respective owners.

For price, delivery, and to place orders: Analog Devices, Inc., One Technology Way, P.O. Box 9106, Norwood, MA 02062-9106 Phone: 781-329-4700 • Order online at www.analog.com Application Support: Phone: 1-800-ANALOG-D



GaAs MMIC 10W T/R SWITCH, 824 - 894 MHz*

Absolute Maximum Ratings

Max. Input Power (Vdd = +8V, V _{CTL} = 0/+8V)	Tx Port Rx Port	41 dBm 33 dBm
Supply Voltage (Vdd)		+10 Vdc
Control Voltage Range (Vctl)		-0.2 to Vdd
Storage Temperature		-65 to +150 °C
Operating Temperature		-40 to +85 °C

Do not operate continuously at power levels > 1 dB compression and do not "hot switch" power levels greater than +36 dBm (Vctl = +8V) into the Tx port and no greater than +27 dBm into the Rx port.

Truth Table

Control Input	Signal Path State	
	Vctl (Vdc)	Tx to RFC
0.0	OFF	ON
Vdd	ON	OFF

Vdd = +5.0V to +8.0V ± 0.2V
Control Input Voltage Tolerances are ± 0.2 Vdc.

DC blocking capacitors are required at ports RFC, Tx and Rx. Inductors are required from Tx to RFC and Rx to RFC. See Application Circuit Herein.



**ELECTROSTATIC SENSITIVE DEVICE
OBSERVE HANDLING PRECAUTIONS**

Outline Drawing

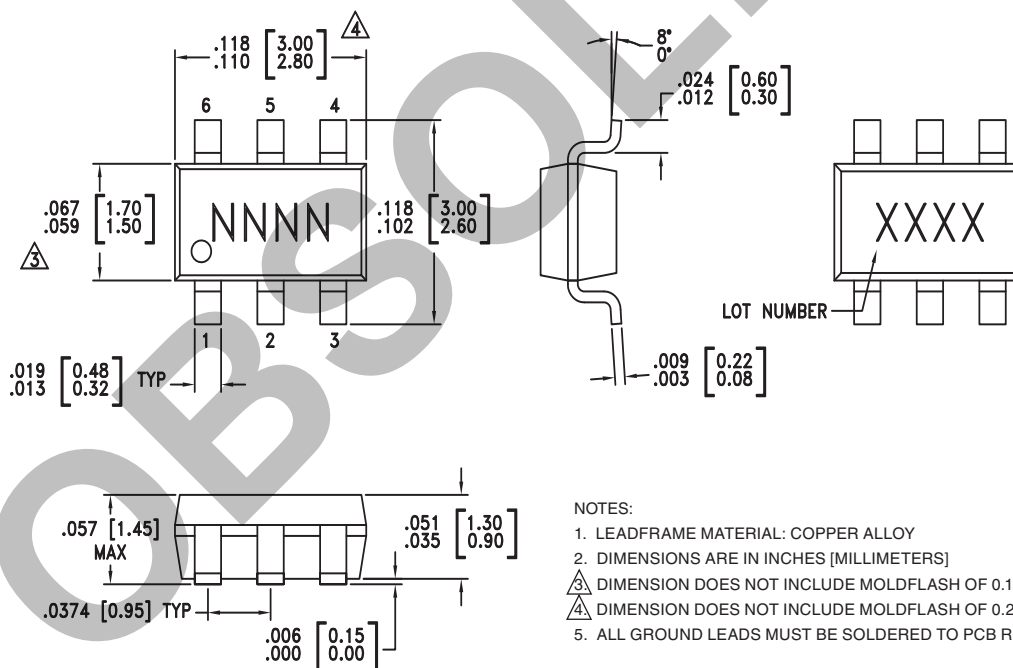

- NOTES:
- LEADFRAME MATERIAL: COPPER ALLOY
 - DIMENSIONS ARE IN INCHES [MILLIMETERS]
 - DIMENSION DOES NOT INCLUDE MOLDFLASH OF 0.15mm PER SIDE.
 - DIMENSION DOES NOT INCLUDE MOLDFLASH OF 0.25mm PER SIDE.
 - ALL GROUND LEADS MUST BE SOLDERED TO PCB RF GROUND

Package Information

Part Number	Package Body Material	Lead Finish	MSL Rating	Package Marking ^[3]
HMC446	Low Stress Injection Molded Plastic	Sn/Pb Solder	MSL1 ^[1]	H446 XXXX
HMC446E	RoHS-compliant Low Stress Injection Molded Plastic	100% matte Sn	MSL1 ^[2]	446E XXXX

[1] Max peak reflow temperature of 235 °C
 [2] Max peak reflow temperature of 260 °C
 [3] 4-Digit lot number XXXX

Information furnished by Analog Devices is believed to be accurate and reliable. However, no responsibility is assumed by Analog Devices for its use, nor for any infringements of patents or other rights of third parties that may result from its use. Specifications subject to change without notice. No license is granted by implication or otherwise under any patent or patent rights of Analog Devices. Trademarks and registered trademarks are the property of their respective owners.

For price, delivery, and to place orders: Analog Devices, Inc., One Technology Way, P.O. Box 9106, Norwood, MA 02062-9106
 Phone: 781-329-4700 • Order online at www.analog.com
 Application Support: Phone: 1-800-ANALOG-D

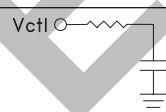

Pin Descriptions

Pin Number	Function	Description	Interface Schematic
1	Tx	This pin is DC coupled and matched to 50 Ohms.	
2	GND	This pin must be connected to PCB RF ground.	
3	Vctl	See Truth Table.	
4	Rx	This pin is DC coupled and matched to 50 Ohms.	
5	Vdd	Supply Voltage	
6	RFC	This pin is DC coupled and matched to 50 Ohms.	

OBSOLETE

Information furnished by Analog Devices is believed to be accurate and reliable. However, no responsibility is assumed by Analog Devices for its use, nor for any infringements of patents or other rights of third parties that may result from its use. Specifications subject to change without notice. No license is granted by implication or otherwise under any patent or patent rights of Analog Devices. Trademarks and registered trademarks are the property of their respective owners.

For price, delivery, and to place orders: Analog Devices, Inc., One Technology Way, P.O. Box 9106, Norwood, MA 02062-9106 Phone: 781-329-4700 • Order online at www.analog.com Application Support: Phone: 1-800-ANALOG-D



Required Application Circuit

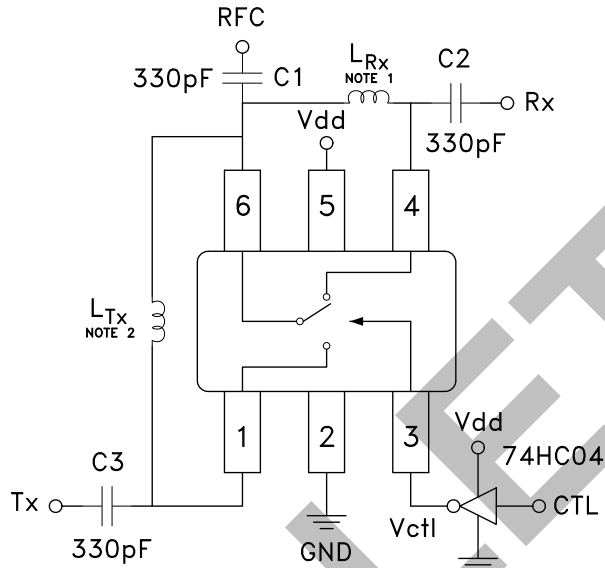

Users must implement this application circuit with the HMC446 T/R switch for proper operation.

Note 1: L_{Rx} = COILCRAFT 0402CS - 8N2XJB, 8.2 nH, 5% Tolerance Inductor

Note 2: L_{Tx} = COILCRAFT 0603CS - 22NXJB, 22 nH, 5% Tolerance Inductor

Note 3: C1, C2, C3 = 330 pF Capacitor

Note 4: External component values can be adjusted to enable HMC446 to operate in other frequency bands. Contact HMC with your specific requirement.

Note 5: Set logic gate & switch Vdd= +8V and use HC series logic to provide a buffered logic interface.



Evaluation PCB

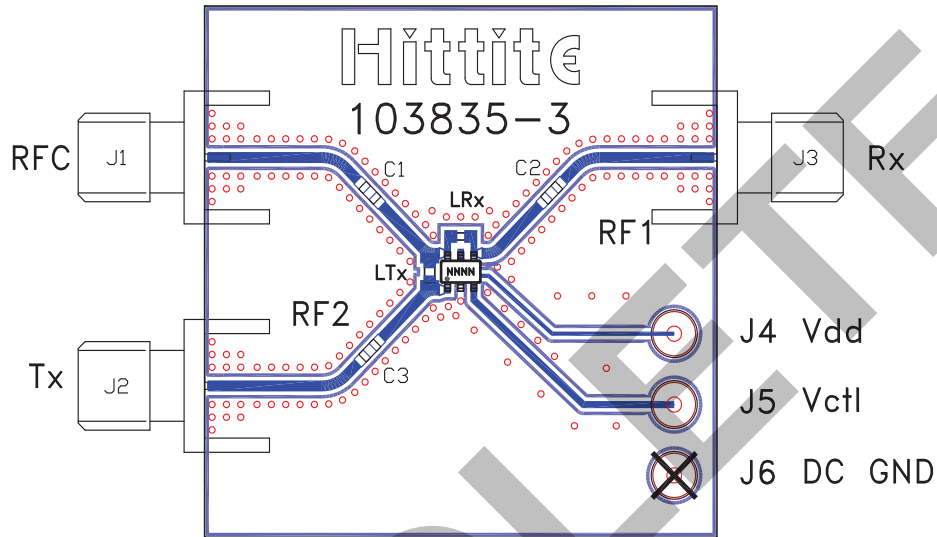

List of Materials for Evaluation PCB 103837 [1]

Item	Description
J1 - J3	PCB Mount SMA RF Connector
J4 - J6	DC Pin
C1 - C3	330 pF Capacitor, 0603 Pkg.
LTx	22 nH Inductor, 0603 Pkg.
LRx	8.2 nH Inductor, 0402 Pkg.
U1	HMC446 / HMC446E T/R Switch
PCB [2]	103835 Evaluation PCB

[1] Reference this number when ordering complete evaluation PCB

[2] Circuit Board Material: Rogers 4350

The circuit board used in the final application should use RF circuit design techniques. Signal lines should have 50 ohm impedance while the package ground leads should be connected directly to the ground plane similar to that shown above. A sufficient number of via holes should be used to connect the top and bottom ground planes. The evaluation circuit board as shown is available from Hittite upon request.