



VPM12-4170

Description:

The toroidal construction inherently reduces stray fields, increases efficiency and minimizes size compared to traditional EI transformers. The addition of a Flux Band further reduces the remaining stray fields. The shield between Primary and Secondary improves safety, reduces common mode signals and minimizes leakage current. Built with a Class F (155°) insulation system. A 140°C self-resetting thermal switch is included in each primary.

Electrical Specifications (@25C)

1. Maximum Power: 50VA
2. Input Voltages: 100, 120, 220, 240VAC, 50/60Hz
3. Output Voltages: 6VAC @ 8.34 A or 12VAC CT @ 4.17A
4. Voltage Regulation: 11.4% TYP from full load to no load
5. Temperature Rise: 45°C TYP
6. Hipot: 4000VAC, Primary to Secondary, Primary & Secondary to Shield & mounting surface
7. Efficiency: 89% TYP. @ full load
8. Earth Leakage: ≤10µA (See Fig. 1), Patient Leakage: ≤ 25µA (see Fig. 2)

Agency File:

UL: File E122529, UL 60601-1/(R) 2012 Medical Electrical Equipment – Part 1 with 2 MOPP
 CE: ES 60601-1 (IEC 60601-1:2005, MOD)
 cUL: C22.2 No. 60601-1:14, Medical Electrical Equipment – Part 1
 CB Certified.



Dimensions: Inches (mm)

O.D.	I.D.	HT.*
3.6 (92)	1.3(32)	1.5(38)

*Add 0.188 (3) to the height for mounting hardware

Weight: 0.7Kg

Mounting:

Transformer is provided with one metal mounting plate, two rubber pads, M5 x 45mm bolt, nut, spring and flat washer.

Connections:

Transformer is provided with 8" (203mm) long, 0.25" (6.35mm) stripped and tinned, stranded UL 1015 lead wire. Primaries are 22AWG, Secondaries are 18AWG, and Shield is 20AWG. The GRN/YEL shield lead is typically grounded. **Do not lift transformer by leads!**

Input Options:

- 100VAC:** Input to Gray & Blue, jumper White & Brown, jumper Blue & Violet.
- 120VAC:** Input to White & Blue, jumper White & Brown, jumper Blue & Violet.
- 220VAC:** Input to Gray & Violet, jumper Blue & Brown
- 240VAC:** Input to White and Violet, jumper Blue & Brown

Output Options:

- 6VAC:** Output from Black & Red, jumper Black & Orange, jumper Red to Yellow
- 12VAC:** Output from Black & Yellow, jumper Red & Orange

Primary and secondary windings are designed to be connected in series or parallel. Windings are not intended to be used independently.

RoHS Compliance: Meets the requirements of 2011/65/EU, known as the RoHS 2 initiative.

* At printing, this document is considered "uncontrolled". Contact Triad Magnetics' website for current version



Photo for illustration only

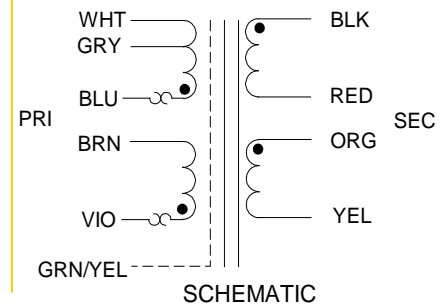
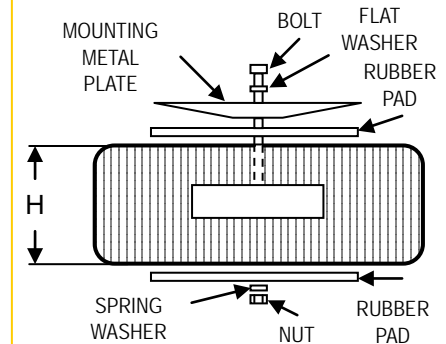
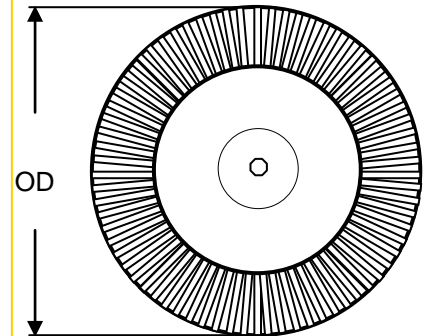



Earth Leakage Current:

V_{in} : Apply 264VAC @60Hz, BLU & BRN - YEL/GRN

Connect resistor and meter between: RED & ORG - YEL/GRN

Leakage Current = 10 μ A MAX

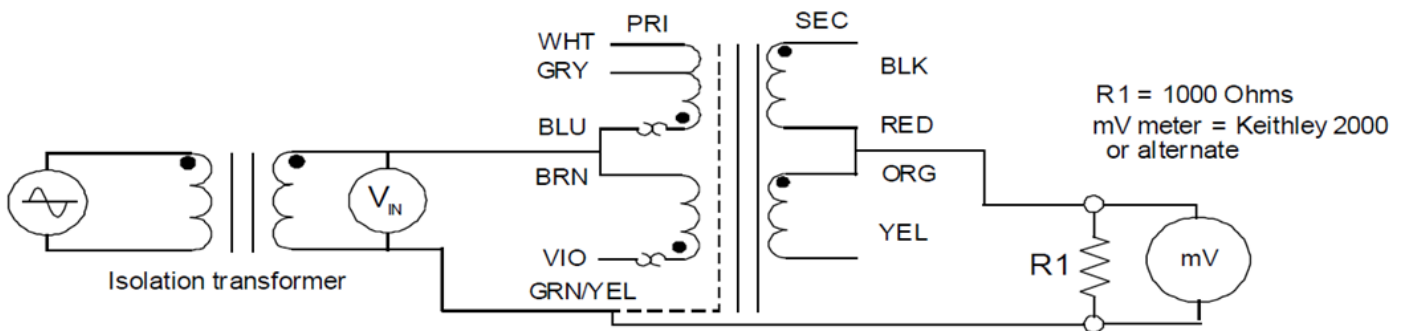

Figure 1

Patient Leakage Current:

V_{in} : Apply 264VAC @60Hz, WHT - VIO,

(Tie BLU & BRN, Tie RED & ORG)

GRN/YEL - BLK = 25 μ ARMS MAX

GRN/YEL - Red & ORG = 25 μ ARMS MAX

GRN/YEL - YEL = 25 μ ARMS MAX



Figure 2