

### Mega Power Dual IGBTMOD™ 900 Amperes/1200 Volts

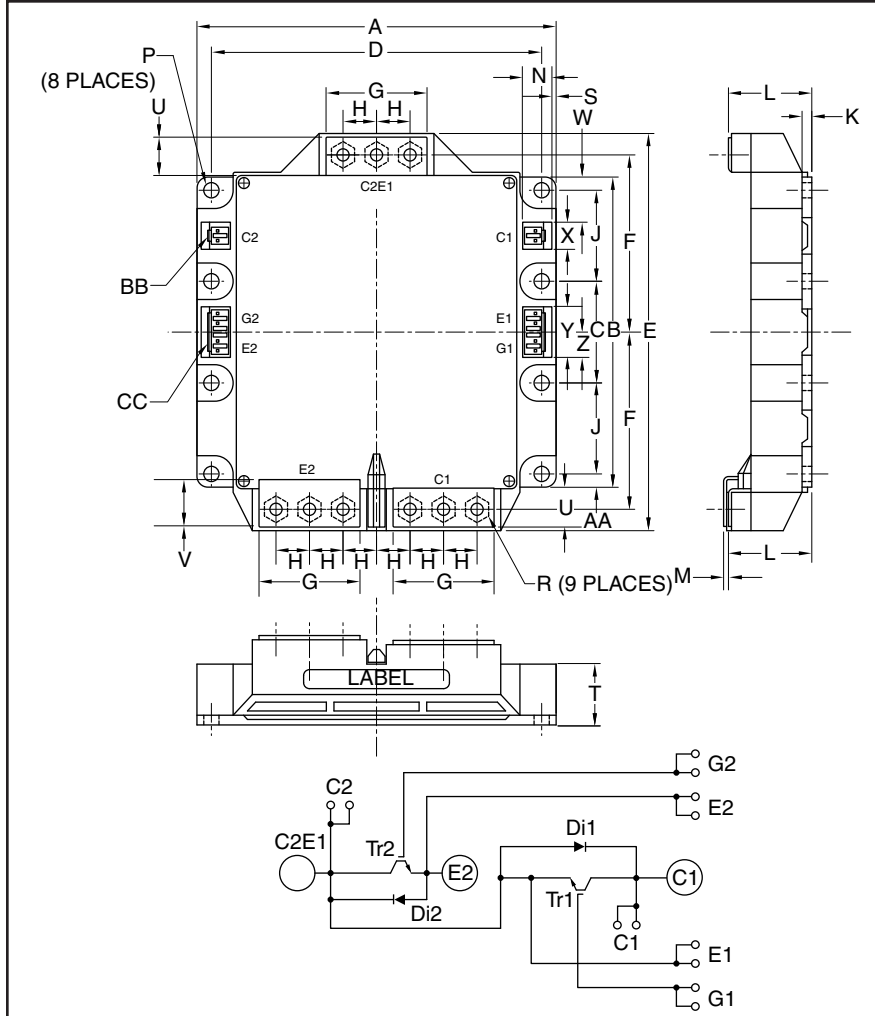

Outline Drawing and Circuit Diagram

Dimensions	Inches	Millimeters
A	5.91	150.0
B	5.10	129.5
C	1.67±0.01	42.5±0.25
D	5.41±0.01	137.5±0.25
E	6.54	166.0
F	2.91±0.01	74.0±0.25
G	1.65	42.0
H	0.55	14.0
J	1.50±0.01	38.0±0.25
K	0.16	4.0
L	1.36 +0.04/-0.02	34.6 +1.0/-0.5

**Housing Type (J.S.T. MFG. CO. LTD)**

BB = VHR-2N  
CC = VHR-5N

Dimensions	Inches	Millimeters
M	0.075±0.008	1.9±0.2
N	0.47	12.0
P	0.26	6.5
R	M6 Metric	M6
S	0.08	2.0
T	0.99	25.1
U	0.62	15.7
V	0.71	18.0
W	0.75	19.0
X	0.43	11.0
Y	0.83	21.0
Z	0.41	10.5
AA	0.22	5.5



**Description:**

Powerex Mega Power Dual (MPD) Modules are designed for use in switching applications. Each module consists of two IGBT Transistors having a reverse-connected super-fast recovery free-wheel diode. All components and interconnects are isolated from the heat sinking baseplate, offering simplified system assembly and thermal management.

**Features:**

- Low Drive Power
- Low  $V_{CE(sat)}$
- Discrete Super-Fast Recovery Free-Wheel Diode
- Isolated Baseplate for Easy Heatsinking
- RoHS Compliant

**Applications:**

- High Power DC Power Supply
- Large DC Motor Drives
- Utility Interface Inverters

**Ordering Information:**

Example: Select the complete module number you desire from the table - i.e. CM900DUC-24NF is a 1200V ( $V_{CES}$ ), 900 Ampere Dual IGBTMOD Power Module.

Type	Current Rating Amperes	$V_{CES}$ Volts (x 50)
CM	900	24



Powerex, Inc., 173 Pavilion Lane, Youngwood, Pennsylvania 15697 (724) 925-7272 www.pwr.com

**CM900DUC-24NF**

**Mega Power Dual IGBTMOD™**

900 Amperes/1200 Volts

**Absolute Maximum Ratings,  $T_j = 25^\circ\text{C}$  unless otherwise specified**

Ratings	Symbol	CM900DUC-24NF	Units
Junction Temperature	$T_j$	-40 to 150	$^\circ\text{C}$
Storage Temperature	$T_{stg}$	-40 to 125	$^\circ\text{C}$
Collector-Emitter Voltage (G-E SHORT)	$V_{CES}$	1200	Volts
Gate-Emitter Voltage (C-E SHORT)	$V_{GES}$	$\pm 20$	Volts
Collector Current DC ( $T_C = 96^\circ\text{C}$ ) <sup>*1</sup>	$I_C$	900	Amperes
Peak Collector Current (Pulse, $T_j \leq 150^\circ\text{C}$ ) <sup>*4</sup>	$I_{CM}$	1800	Amperes
Emitter Current ( $T_C = 25^\circ\text{C}$ )	$I_E$ <sup>*3</sup>	900	Amperes
Peak Emitter Current (Pulse) <sup>*4</sup>	$I_{EM}$ <sup>*3</sup>	1800	Amperes
Maximum Collector Dissipation ( $T_j < 150^\circ\text{C}$ , $T_C = 25^\circ\text{C}$ ) <sup>*1</sup>	$P_C$	5900	Watts
Mounting Torque, M6 Mounting Screws	–	40	in-lb (max.)
Mounting Torque, M6 Main Terminal Screw	–	40	in-lb (max.)
Weight (Typical)	–	1450	Grams
Isolation Voltage (Main Terminal to Baseplate, AC 1 min.)	$V_{iso}$	2500	Volts

\*1 Case temperature  $T_C$  and heatsink temperature ( $T_f$ ) measured point is just under the chips.

\*3  $I_E$ ,  $I_{EM}$ ,  $V_{EC}$ ,  $I_{FSM}$ ,  $I^2t$ ,  $t_{rr}$ ,  $Q_{rr}$  represent ratings and characteristics of the anti-parallel, emitter-to-collector free-wheel diode (FWDi).

\*4 Pulse width and repetition rate should be such that device junction temperature ( $T_j$ ) does not exceed  $T_{j(max)}$  rating.



**CM900DUC-24NF**  
**Mega Power Dual IGBTMOD™**  
 900 Amperes/1200 Volts

**Electrical Characteristics,  $T_j = 25^\circ\text{C}$  unless otherwise specified**

Characteristics	Symbol	Test Conditions	Min.	Typ.	Max.	Units
Collector-Cutoff Current	$I_{CES}$	$V_{CE} = V_{CES}, V_{GE} = 0V$	–	–	1	mA
Gate-Emitter Threshold Voltage	$V_{GE(th)}$	$I_C = 90mA, V_{CE} = 10V$	6	7	8	Volts
Gate Leakage Current	$I_{GES}$	$V_{GE} = V_{GES}, V_{CE} = 0V$	–	–	1.0	$\mu A$
Collector-Emitter Saturation Voltage (Chip)	$V_{CE(sat)}$	$I_C = 900A, V_{GE} = 15V, T_j = 25^\circ\text{C}^{*6}$	–	1.8	2.5	Volts
(Without Lead Resistance)		$I_C = 900A, V_{GE} = 15V, T_j = 125^\circ\text{C}^{*6}$	–	2.0	–	Volts
Module Lead Resistance	$R_{(lead)}$	$I_C = 900A, \text{Terminal-Chip}$	–	0.286	–	m $\Omega$
Input Capacitance	$C_{ies}$		–	–	140	nF
Output Capacitance	$C_{oes}$	$V_{CE} = 10V, V_{GE} = 0V$	–	–	16	nF
Reverse Transfer Capacitance	$C_{res}$		–	–	3	nF
Total Gate Charge	$Q_G$	$V_{CC} = 600V, I_C = 900A, V_{GE} = 15V$	–	4800	–	nC
Inductive Turn-on Delay Time	$t_{d(on)}$	$V_{CC} = 600V, I_C = 900A,$	–	–	600	ns
Load Rise Time	$t_r$	$V_{GE1} = V_{GE2} = 15V,$	–	–	200	ns
Switch Turn-off Delay Time	$t_{d(off)}$	$R_G = 0.35\Omega, \text{Inductive Load}$	–	–	800	ns
Times Fall Time	$t_f$	Switching Operation	–	–	300	ns
Reverse Recovery Time	$t_{rr}^{*3}$	$I_E = 900A$	–	–	500	ns
Reverse Recovery Charge	$Q_{rr}^{*3}$		–	50	–	$\mu C$
Emitter-Collector Voltage (Chip)	$V_{EC}^{*3}$	$I_E = 900A, V_{GE} = 0V^{*6}$	–	–	3.2	Volts
(Without Lead resistance)						
External Gate Resistance	$R_G$		0.35	–	2.2	$\Omega$

**Thermal and Mechanical Characteristics,  $T_j = 25^\circ\text{C}$  unless otherwise specified**

Characteristics	Symbol	Test Conditions	Min.	Typ.	Max.	Units
Thermal Resistance, Junction to Case <sup>*1</sup>	$R_{th(j-c)Q}$	Per IGBT (1/2 Module)	–	–	0.021	$^\circ\text{C/W}$
Thermal Resistance, Junction to Case <sup>*1</sup>	$R_{th(j-c)D}$	Per Clamp Diode (1/2 Module)	–	–	0.034	$^\circ\text{C/W}$
Contact Thermal Resistance <sup>*1</sup>	$R_{th(c-f)}$	Thermal Grease Applied (1/2 Module)	–	0.012	–	$^\circ\text{C/W}$

\*1 Case temperature  $T_C$  and heatsink temperature ( $T_f$ ) measured point is just under the chips.

\*3  $I_E, I_{EM}, V_{EC}, I_{FSM}, I^2t, t_{rr}, Q_{rr}$  represent ratings and characteristics of the anti-parallel, emitter-to-collector free-wheel diode (FWDi).

\*6 Pulse width and repetition rate should be such as to cause negligible temperature rise.

**CM900DUC-24NF**  
**Mega Power Dual IGBTMOD™**  
 900 Amperes/1200 Volts

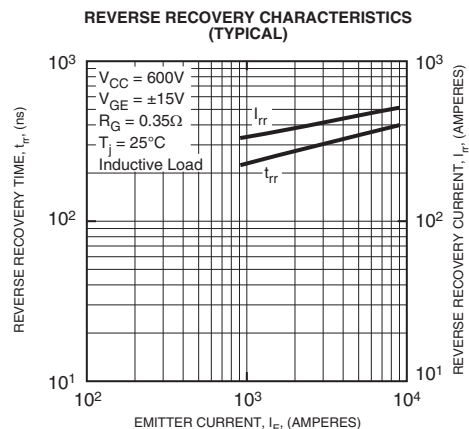
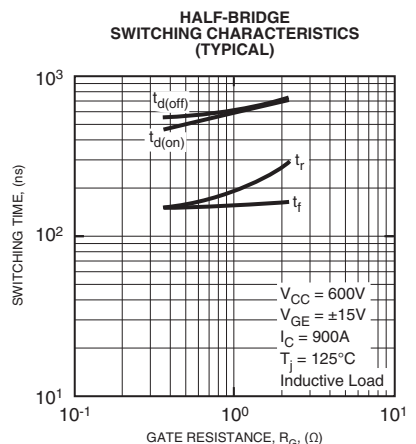
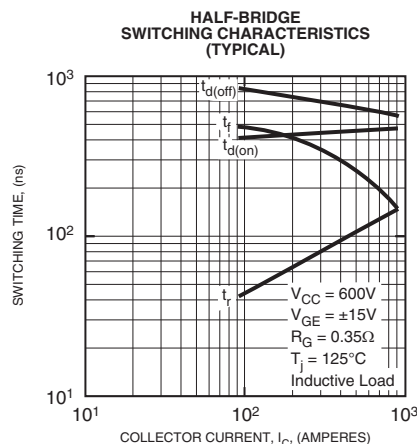
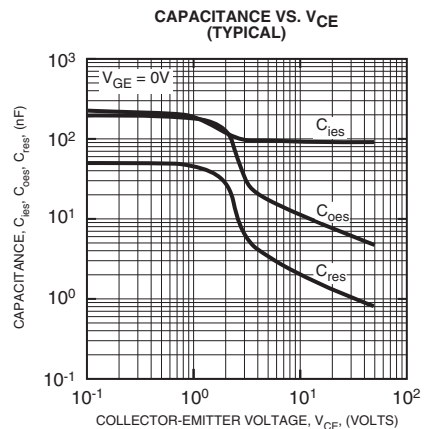
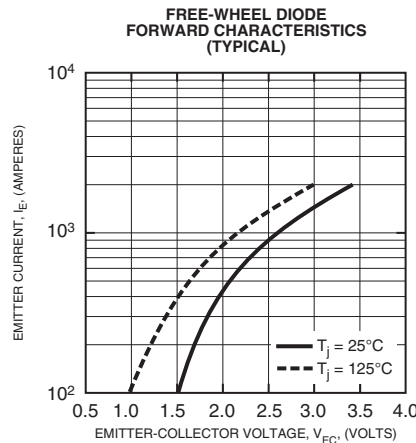
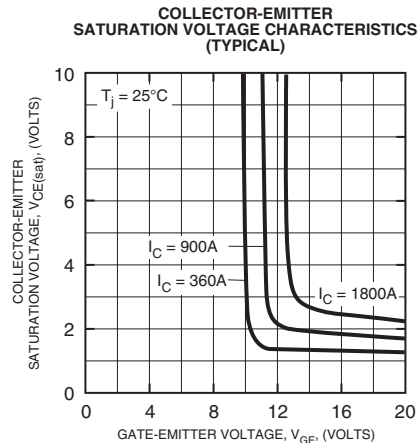
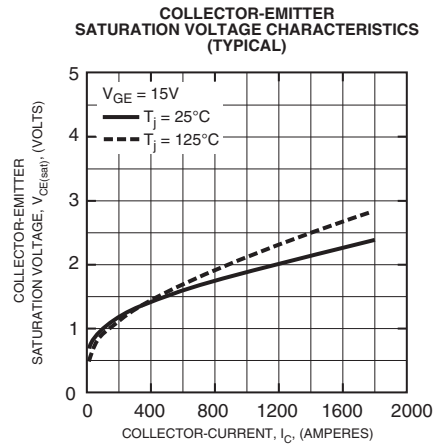
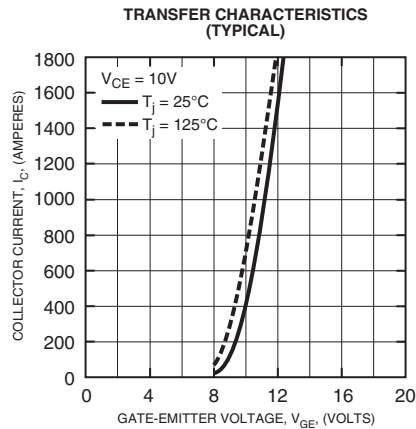
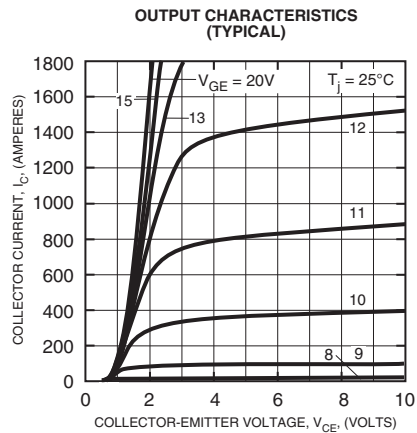



Powerex, Inc., 173 Pavilion Lane, Youngwood, Pennsylvania 15697 (724) 925-7272 www.pwr.com

**CM900DUC-24NF**  
**Mega Power Dual IGBTMOD™**  
 900 Amperes/1200 Volts

