

**Product number C12041_EVA-S**

Family	Eva	FWHM	13 degrees
Type	Lens	Efficiency	94 %
LED	XM-L	cd/lm	-
Color	Clear	Gerber File	Available
Diameter	35 mm	Outer flange can be secured in fixture for hardware-free attachment	
Height	16.4 mm		
Style	Round		
Optic Material	PMMA		
Holder Material	-		
Fastening	-		
Status	Production ready		

**Product number CA12055_EVA-S**

Family	Eva	FWHM	13 degrees
Type	Assembly	Efficiency	92 %
LED	XM-L	cd/lm	-
Color	Black	Gerber File	Available
Diameter	37.7 mm		
Height	17.2 mm		
Style	Round		
Optic Material	PMMA		
Holder Material	-		
Fastening	["tape", "screw"]		
Status	Production ready		

**Product number CP12196_EVA-S**

Family	Eva	FWHM	13 degrees
Type	Assembly	Efficiency	94 %
LED	XM-L	cd/lm	-
Color	Black	Gerber File	Available
Diameter	37.7 mm		
Height	17 mm		
Style	Round		
Optic Material	PMMA		
Holder Material	-		
Fastening	["glue", "screw"]		
Status	Production ready		

**Product number C12828_EVA-O**

Family	Eva	FWHM	15.5+39 degrees
Type	Lens	Efficiency	86 %
LED	XM-L	cd/lm	3.300
Color	Clear	Gerber File	Available
Diameter	35 mm		
Height	16.4 mm		
Style	Round		
Optic Material	PMMA		
Holder Material	-		
Fastening	-		
Status	Production ready		

**Product number CA12859_EVA-O**

Family	Eva	FWHM	15.5+39 degrees
Type	Assembly	Efficiency	86 %
LED	XM-L	cd/lm	3.300
Color	Black	Gerber File	Available
Diameter	37.7 mm		
Height	17.2 mm		
Style	Round		
Optic Material	PMMA		
Holder Material	-		
Fastening	["tape"]		
Status	Production ready		

**Product number CP12860_EVA-O**

Family	Eva	FWHM	15.5+39 degrees
Type	Assembly	Efficiency	86 %
LED	XM-L	cd/lm	3.300
Color	Black	Gerber File	Available
Diameter	37.7 mm		
Height	17 mm		
Style	Round		
Optic Material	PMMA		
Holder Material	-		
Fastening	["screw"]		
Status	Production ready		

**Product number C10684_EVA-D**

Family	Eva	FWHM	16 degrees
Type	Lens	Efficiency	91 %
LED	XM-L	cd/lm	-
Color	Clear	Gerber File	Available
Diameter	35 mm		
Height	16.4 mm		
Style	Round		
Optic Material	PMMA		
Holder Material	-		
Fastening	-		
Status	Production ready		

Outer flange can be secured in fixture for hardware-free attachment.

**Product number CA12057_EVA-D**

Family	Eva	FWHM	16 degrees
Type	Assembly	Efficiency	90 %
LED	XM-L	cd/lm	-
Color	Black	Gerber File	Available
Diameter	37.7 mm		
Height	17.2 mm		
Style	Round		
Optic Material	PMMA		
Holder Material	-		
Fastening	["tape", "screw"]		
Status	Production ready		

**Product number CP12197_EVA-D**

Family	Eva	FWHM	20 degrees
Type	Assembly	Efficiency	91 %
LED	XM-L	cd/lm	-
Color	Black	Gerber File	Available
Diameter	37.7 mm		
Height	17 mm		
Style	Round		
Optic Material	PMMA		
Holder Material	-		
Fastening	["glue", "screw"]		
Status	Production ready		

**Product number C10685_EVA-M**

Family	Eva	FWHM	24 degrees
Type	Lens	Efficiency	88 %
LED	XM-L	cd/lm	-
Color	Clear	Gerber File	Available
Diameter	35 mm		
Height	16.4 mm		
Style	Round		
Optic Material	PMMA		
Holder Material	-		
Fastening	-		
Status	Production ready		

Outer flange can be secured in fixture for hardware-free attachment

**Product number CA12058_EVA-M**

Family	Eva	FWHM	24 degrees
Type	Assembly	Efficiency	89 %
LED	XM-L	cd/lm	-
Color	Black	Gerber File	Available
Diameter	37.7 mm		
Height	17.2 mm		
Style	Round		
Optic Material	PMMA		
Holder Material	-		
Fastening	["tape", "screw"]		
Status	Production ready		

**Product number CP12198_EVA-M**

Family	Eva	FWHM	24 degrees
Type	Assembly	Efficiency	88 %
LED	XM-L	cd/lm	-
Color	Black	Gerber File	Available
Diameter	37.7 mm		
Height	17 mm		
Style	Round		
Optic Material	PMMA		
Holder Material	-		
Fastening	["glue", "screw"]		
Status	Production ready		

**Product number C10686_EVA-W**

Family	Eva	FWHM	40 degrees
Type	Lens	Efficiency	79 %
LED	XM-L	cd/Im	-
Color	Clear	Gerber File	Available
Diameter	35 mm	Outer flange can be secured in fixture for hardware-free attachment	
Height	16.4 mm		
Style	Round		
Optic Material	PMMA		
Holder Material	-		
Fastening	-		
Status	Production ready		

**Product number CA12059_EVA-W**

Family	Eva	FWHM	40 degrees
Type	Assembly	Efficiency	83 %
LED	XM-L	cd/Im	-
Color	Black	Gerber File	Available
Diameter	37.7 mm		
Height	17.2 mm		
Style	Round		
Optic Material	PMMA		
Holder Material	-		
Fastening	["tape", "screw"]		
Status	Production ready		

**Product number CP12199_EVA-W**

Family	Eva	FWHM	40 degrees
Type	Assembly	Efficiency	79 %
LED	XM-L	cd/Im	-
Color	Black	Gerber File	Available
Diameter	37.7 mm		
Height	17 mm		
Style	Round		
Optic Material	PMMA		
Holder Material	-		
Fastening	["screw", "glue"]		
Status	Production ready		

**Product number C10909_EVA-WW**

Family	Eva	FWHM	64 degrees
Type	Lens	Efficiency	77 %
LED	XM-L	cd/Im	-
Color	Clear	Gerber File	Available
Diameter	35 mm	Outer flange can be secured in fixture for hardware-free attachment	
Height	16.4 mm		
Style	Round		
Optic Material	PMMA		
Holder Material	-		
Fastening	-		
Status	Production ready		

PRODUCT DATASHEET

Eva series

last update 20/12/2012

**Product number CA12060_EVA-WW**

Family	Eva	FWHM	64 degrees
Type	Assembly	Efficiency	79 %
LED	XM-L	cd/lm	-
Color	Black	Gerber File	Available
Diameter	37.7 mm		
Height	17.2 mm		
Style	Round		
Optic Material	PMMA		
Holder Material	-		
Fastening	["screw", "tape"]		
Status	Production ready		

**Product number CP12200_EVA-WW**

Family	Eva	FWHM	64 degrees
Type	Assembly	Efficiency	77 %
LED	XM-L	cd/lm	-
Color	Black	Gerber File	Available
Diameter	37.7 mm		
Height	17 mm		
Style	Round		
Optic Material	PMMA		
Holder Material	-		
Fastening	["screw", "glue"]		
Status	Production ready		

NOTE: The typical divergence will be changed by different color, chip size and chip position tolerance. The typical total divergence is the full angle measured where the luminous intensity is half of the peak value.



PRODUCT DATASHEET

Eva series

last update 20/12/2012

GENERAL INFORMATION

- Product series especially designed & optimized for XM-L series of LEDs.
- Special care taken to make light distribution as uniform as possible.
- Lens material optical grade PMMA with high UV and temperature resistance. Allows use of high current and temperature conditions.

Please find more information about used material from below:

http://ledil.fi/sites/default/files/Documents/Technical/Material/PMMA%20N%20UL94_Yellow%20Card.pdf

<http://ledil.fi/sites/default/files/Documents/Technical/Material/PMMA%20N%20PLEXIGLAS-Datasheet.pdf>

Relative intensity of CA12059_Eva-W-XM-Tape

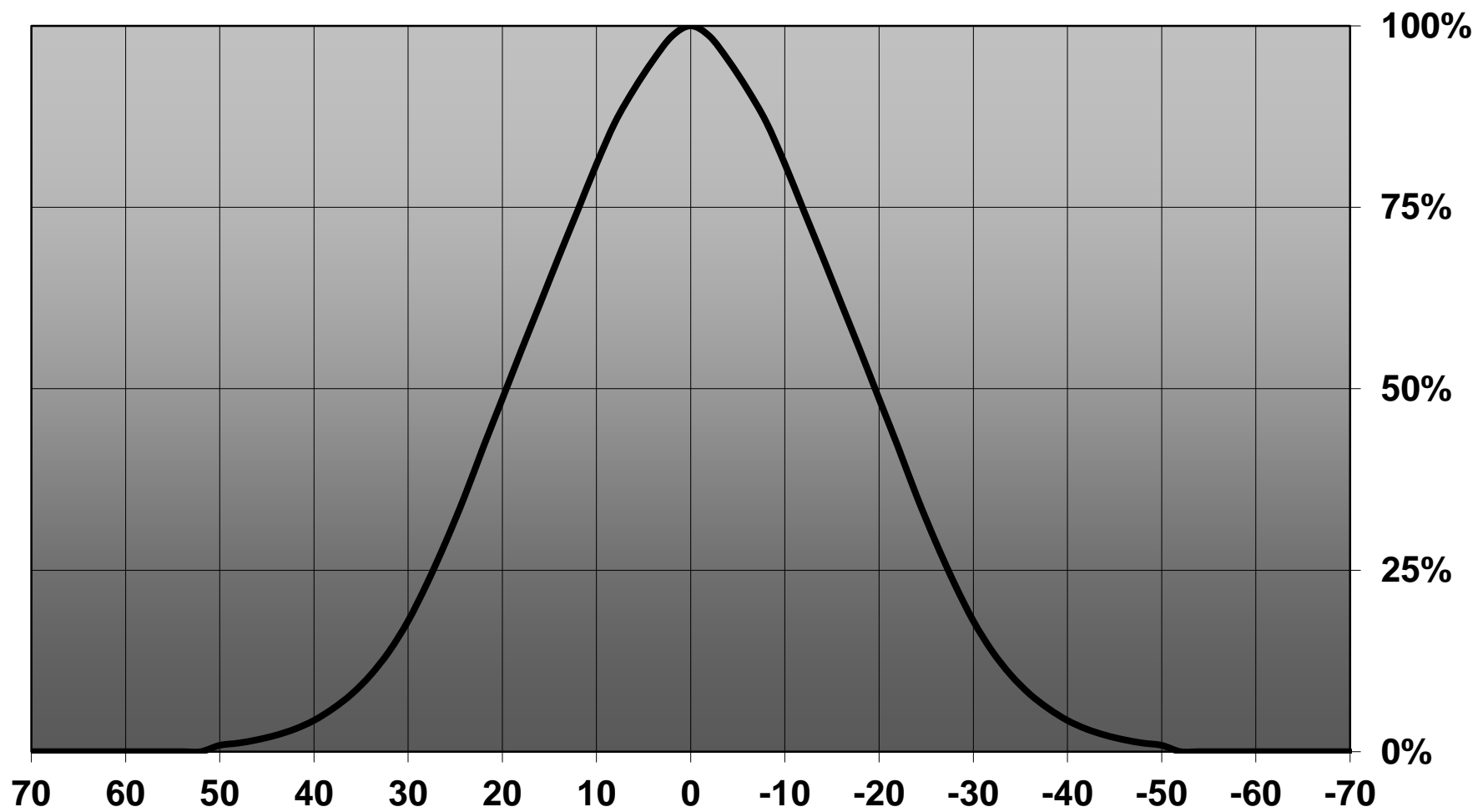

D

C

B

A

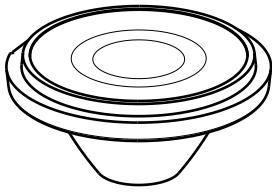

Isometric view

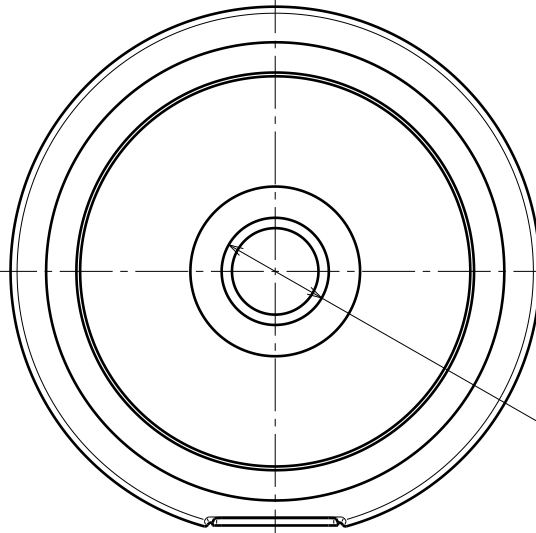

Bottom view

Ø 6.8

Ø 30.5

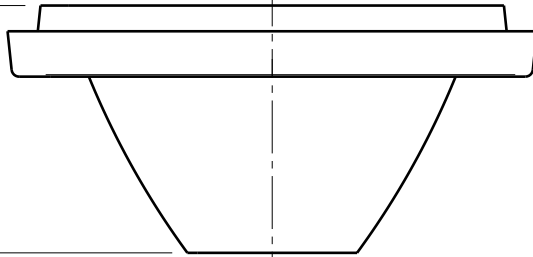

Side view

16.4

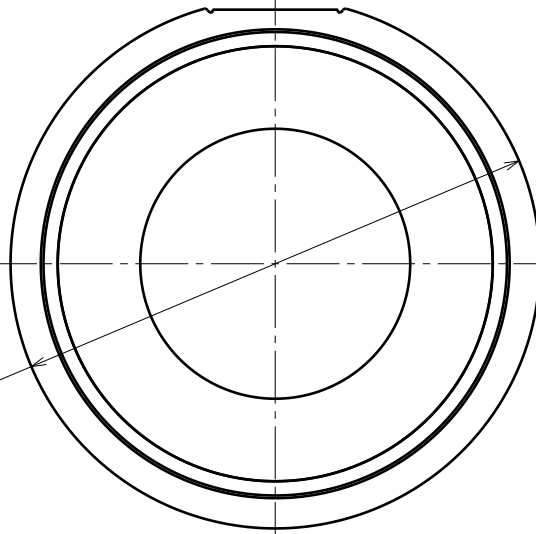

Top view

Ø 35

Tolerances if not otherwise shown:
 According to DIN ISO 2768-1
 Linear measures:
 Up to 30mm class M, otherwise class C.

According to DIN ISO 2768-2
 Form and position:
 class L

Raw material(s):
 PMMA 8N

This drawing is our property.
 It can't be reproduced
 or communicated without
 our written agreement.



Ledil Oy
 Salorankatu 10
 24100 SALO
 Finland

DRAWING TITLE

Datasheet Eva Spot Lens

DRAWN BY
 ah

DATE
 1.3.2013

CHECKED BY

DATE

SIZE
 A4

DRAWING NUMBER

C12041

REV
 1

DESIGNED BY
 HH

DATE
 26.08.2008

SCALE

2:1

WEIGHT (g)

SHEET

1/1

D

A

4

3

2

1

1

Ledil CA12055_Eva-S-XM-Tape CA12055_Eva-S-XM-Tape / LDC (Linear)

Luminaire: Ledil CA12055_Eva-S-XM-Tape CA12055_Eva-S-XM-Tape
Lamps: 1 x LED Module

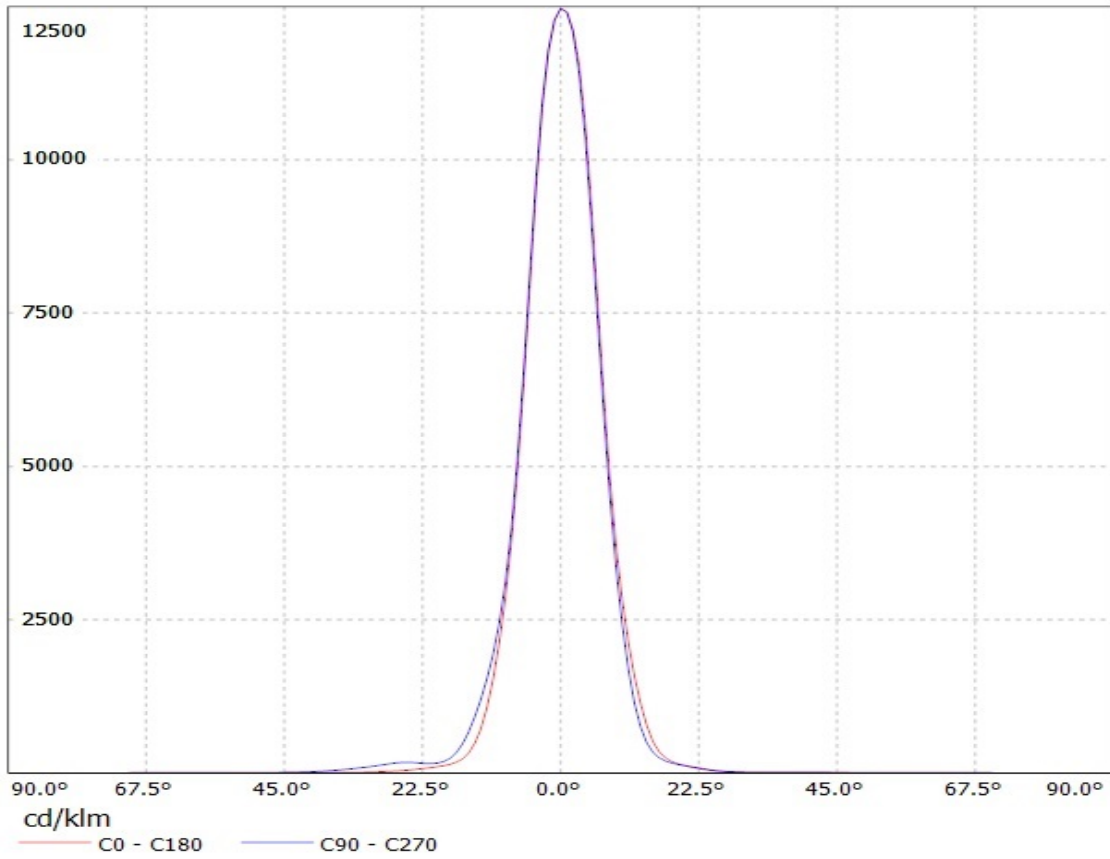

SIMULATED

Luminaire: LEDIL OY C12828_EVA-O (XM-L) Efficiency=86%
Lamps: 1 x Cree XM-L (111lm @ 250mA)

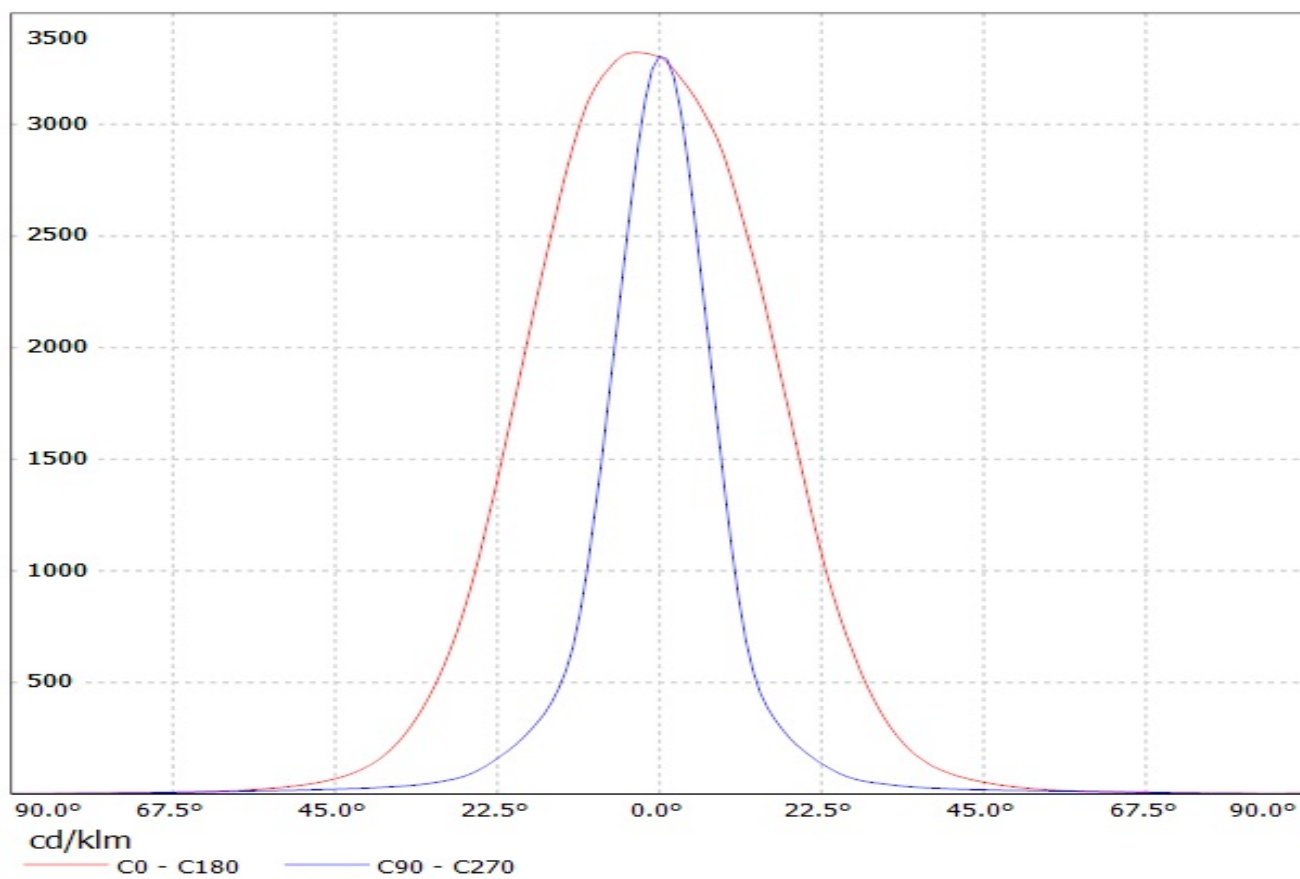

Luminaire: LEDIL OY CA12859_EVA-O / CP12860_EVA-O (XM-L) Efficiency=86%
Lamps: 1 x Cree XM-L (111lm @ 250mA)

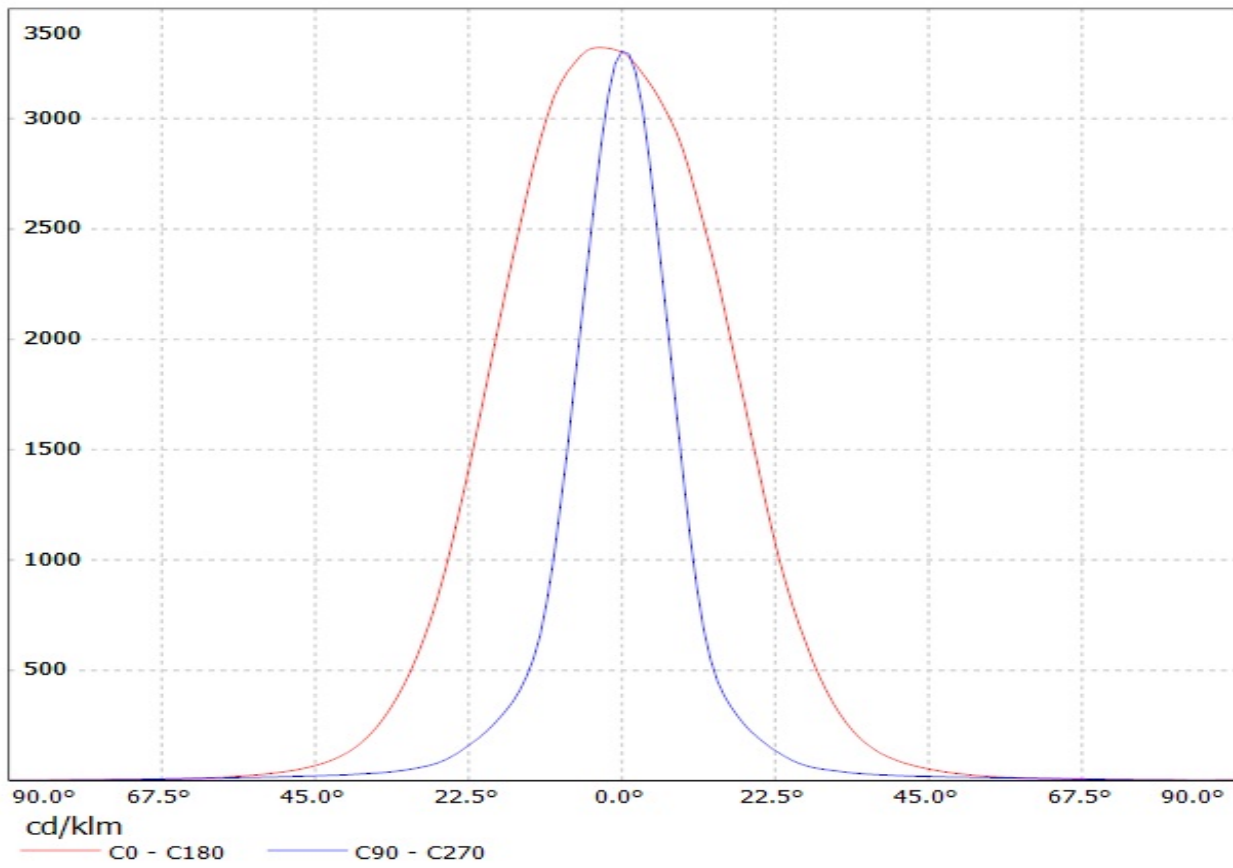

Luminaire: LEDIL OY CA12859_EVA-O / CP12860_EVA-O (XM-L) Efficiency=86%
Lamps: 1 x Cree XM-L (111lm @ 250mA)

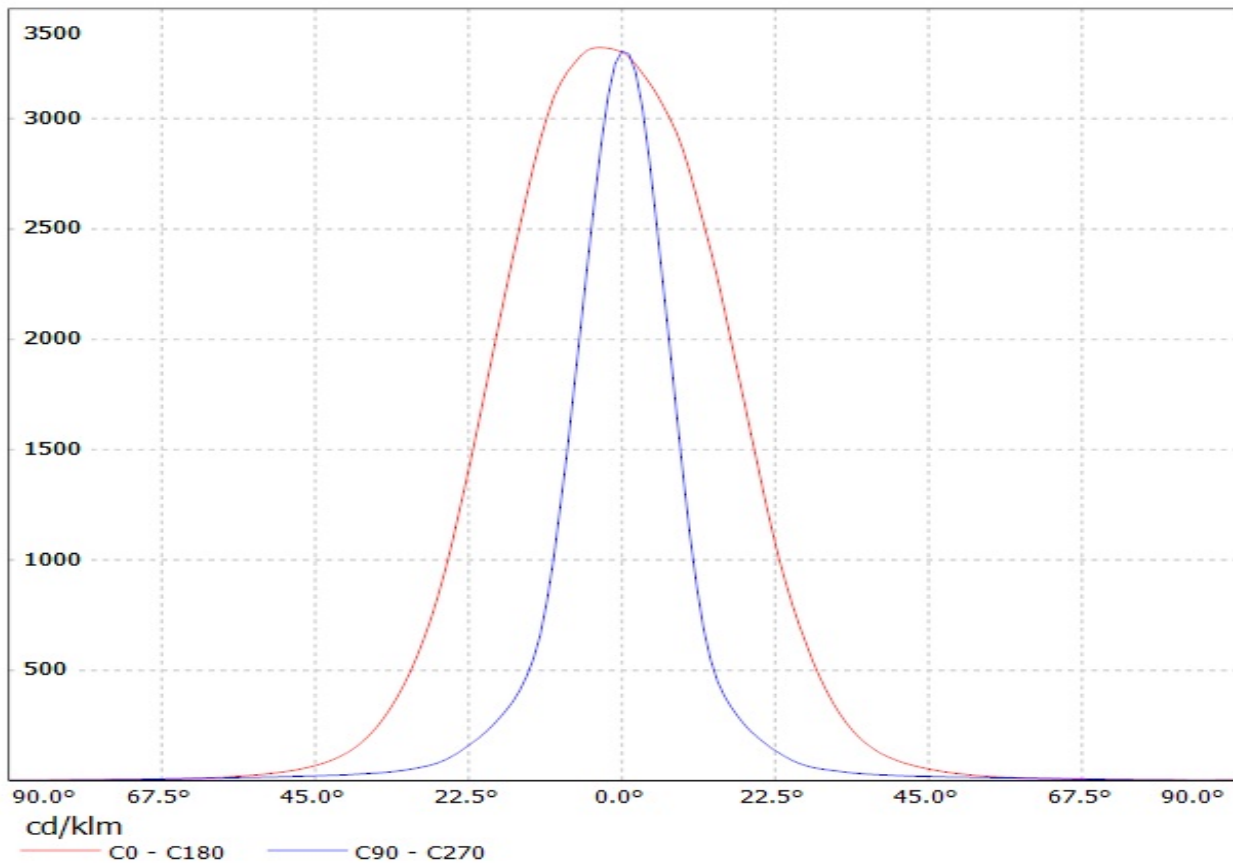

Ledil CA12055_Eva-S-XM-Tape CA12055_Eva-S-XM-Tape / LDC (Linear)

Luminaire: Ledil CA12055_Eva-S-XM-Tape CA12055_Eva-S-XM-Tape
Lamps: 1 x LED Module

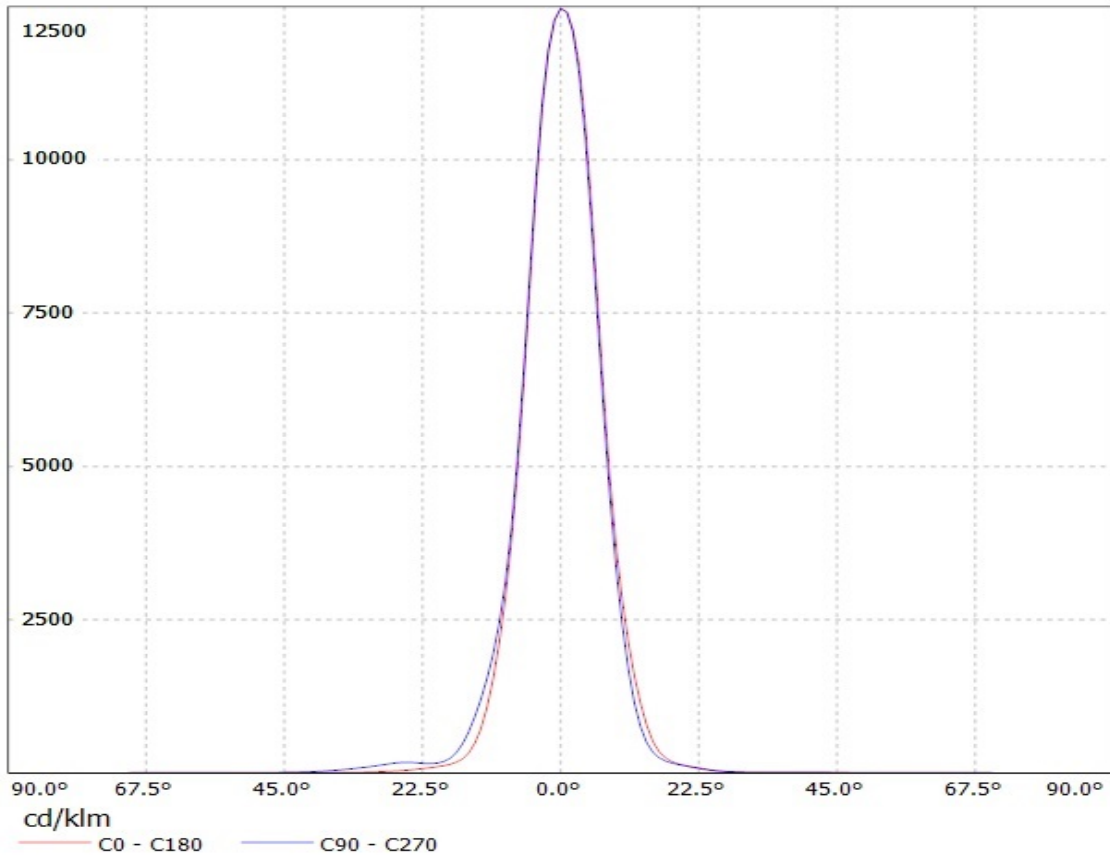

SIMULATED

Ledil CA12055_Eva-S-XM-Tape CA12055_Eva-S-XM-Tape / LDC (Linear)

Luminaire: Ledil CA12055_Eva-S-XM-Tape CA12055_Eva-S-XM-Tape
Lamps: 1 x LED Module

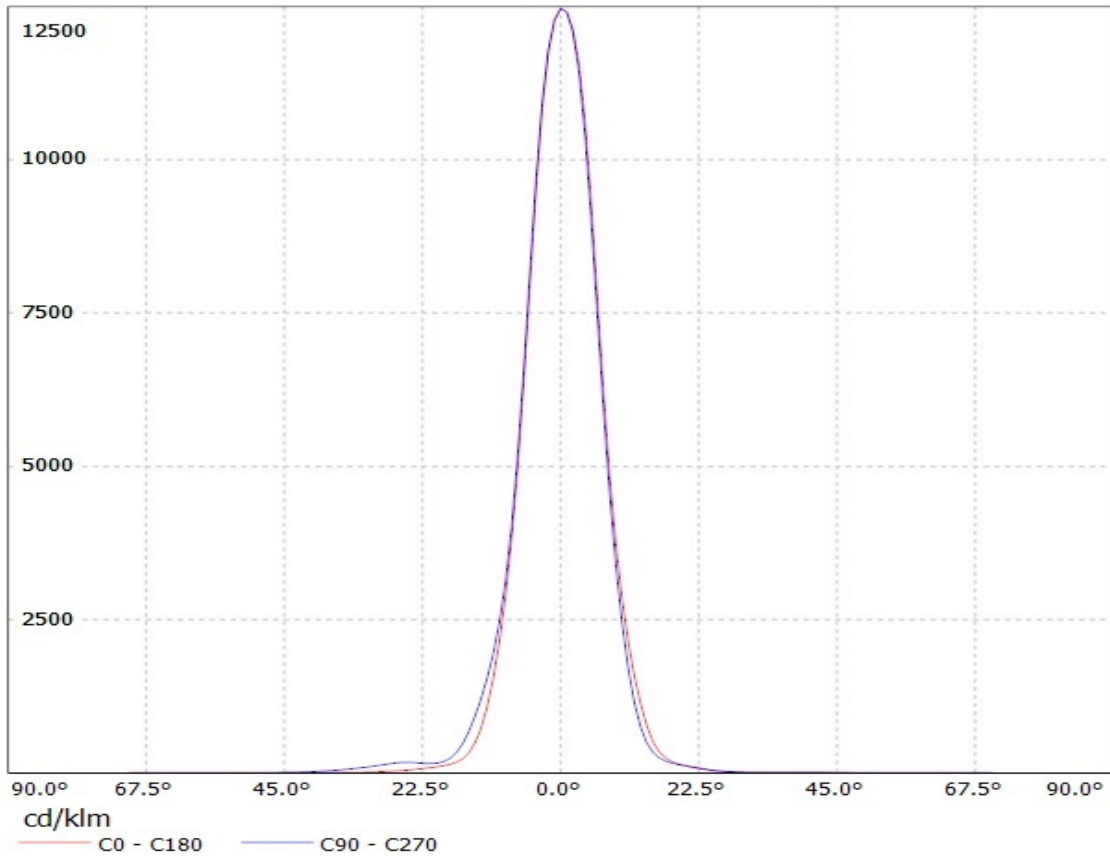

SIMULATED

Ledil Oy CA12059_Eva-W-XM-Tape CA12059_Eva-W-XM-Tape / LDC (Linear)

Luminaire: Ledil Oy CA12059_Eva-W-XM-Tape CA12059_Eva-W-XM-Tape

Lamps: 1 x Cree XM-L white

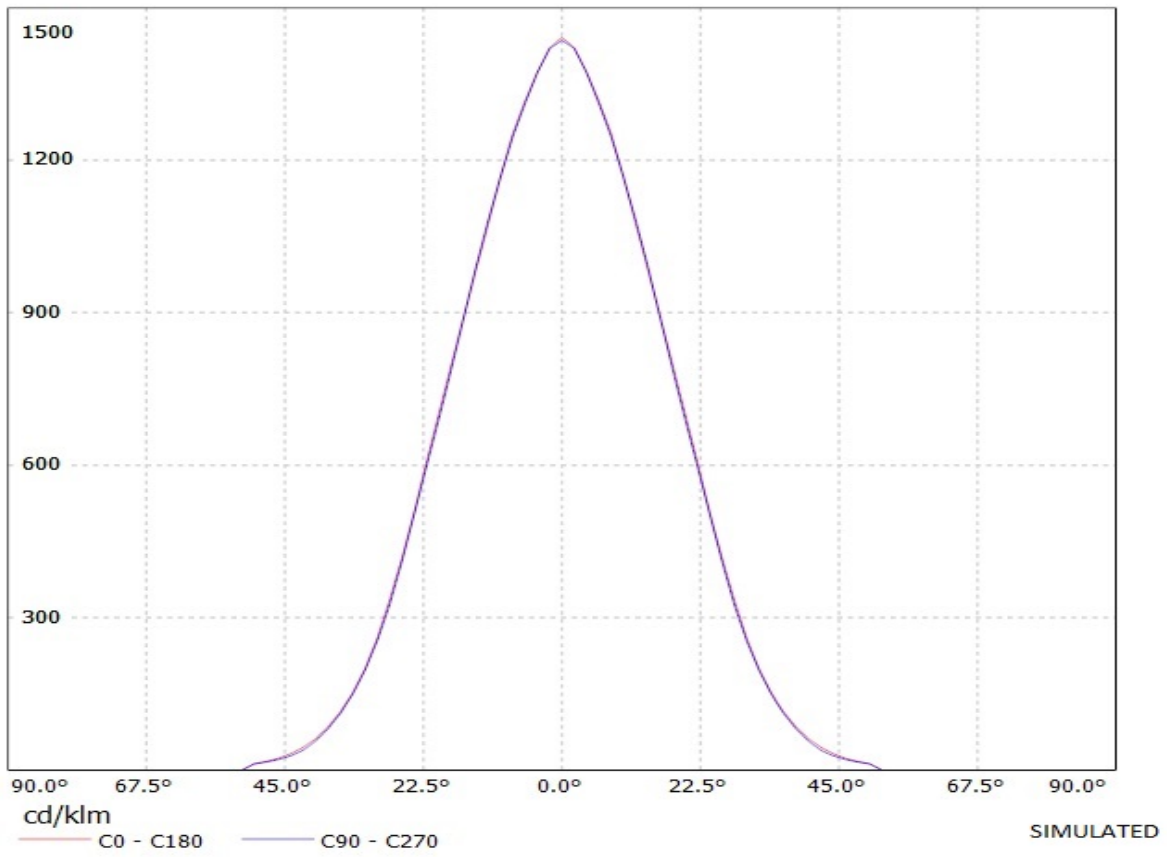

Ledil Oy C10909_CA12060_Eva-WW-XM-Tape C10909_CA12060_Eva-WW-XM-Tape / LDC (Linear)

Luminaire: Ledil Oy C10909_CA12060_Eva-WW-XM-Tape C10909_CA12060_Eva-WW-XM-Tape
Lamps: 1 x Cree XM-L

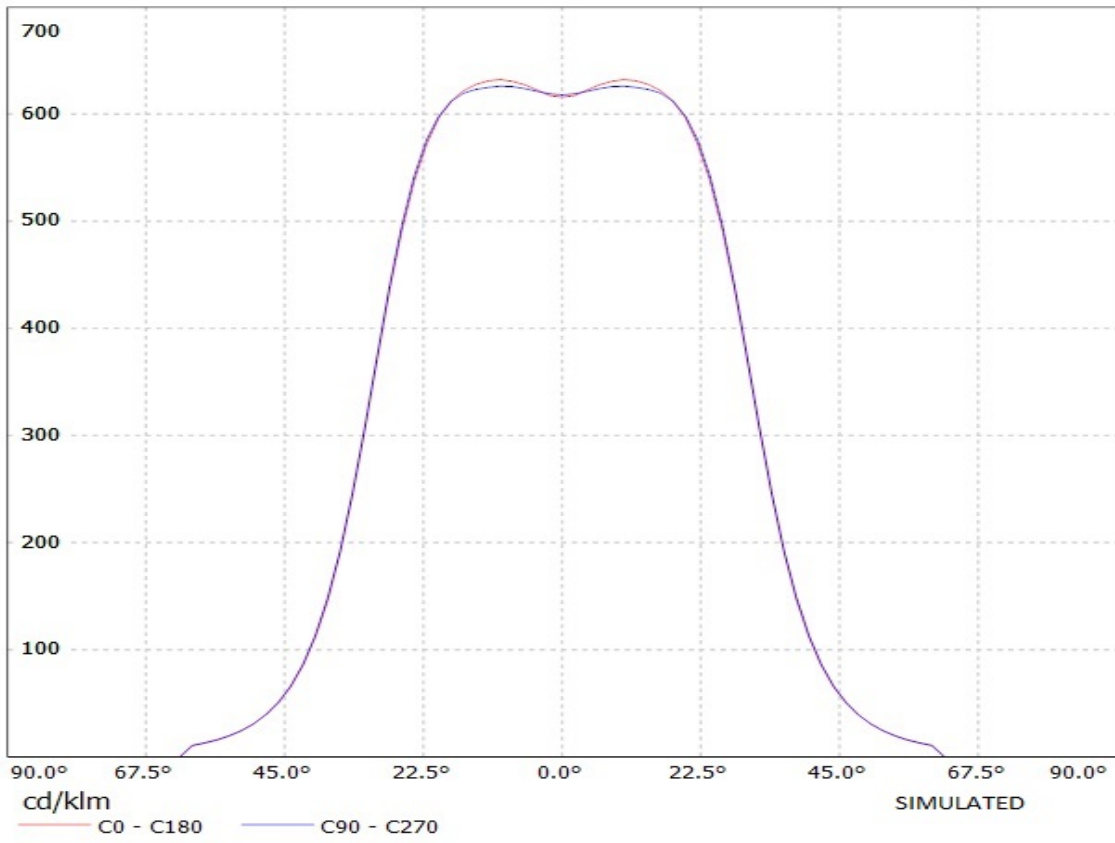

Ledil CA12055_Eva-S-XM-Tape CA12055_Eva-S-XM-Tape / LDC (Polar)

Luminaire: Ledil CA12055_Eva-S-XM-Tape CA12055_Eva-S-XM-Tape

Lamps: 1 x LED Module

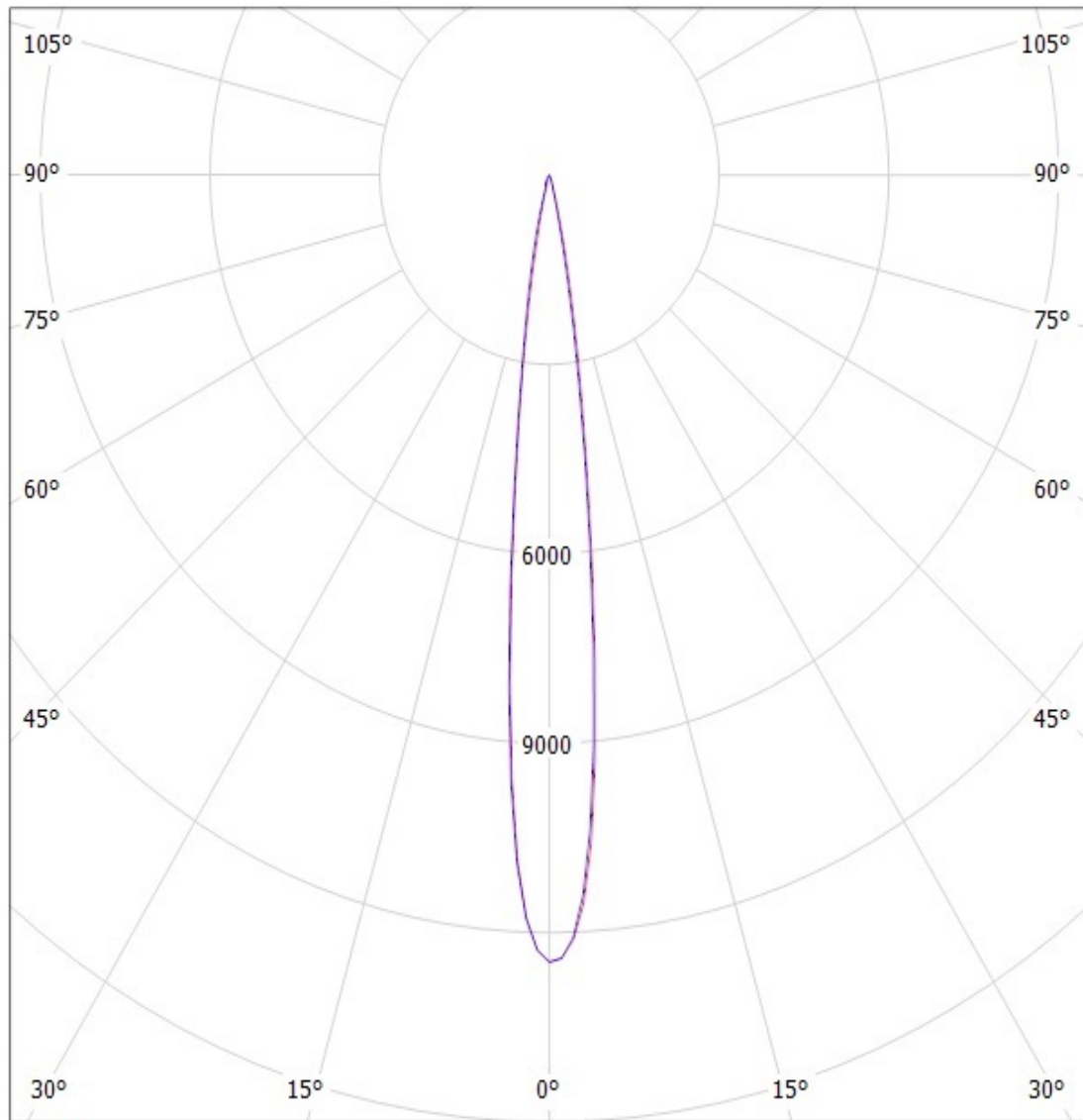

cd/klm

SIMULATED

— C0 - C180 — C90 - C270

Luminaire: LEDIL OY C12828_EVA-O (XM-L) Efficiency=86%
Lamps: 1 x Cree XM-L (111lm @ 250mA)

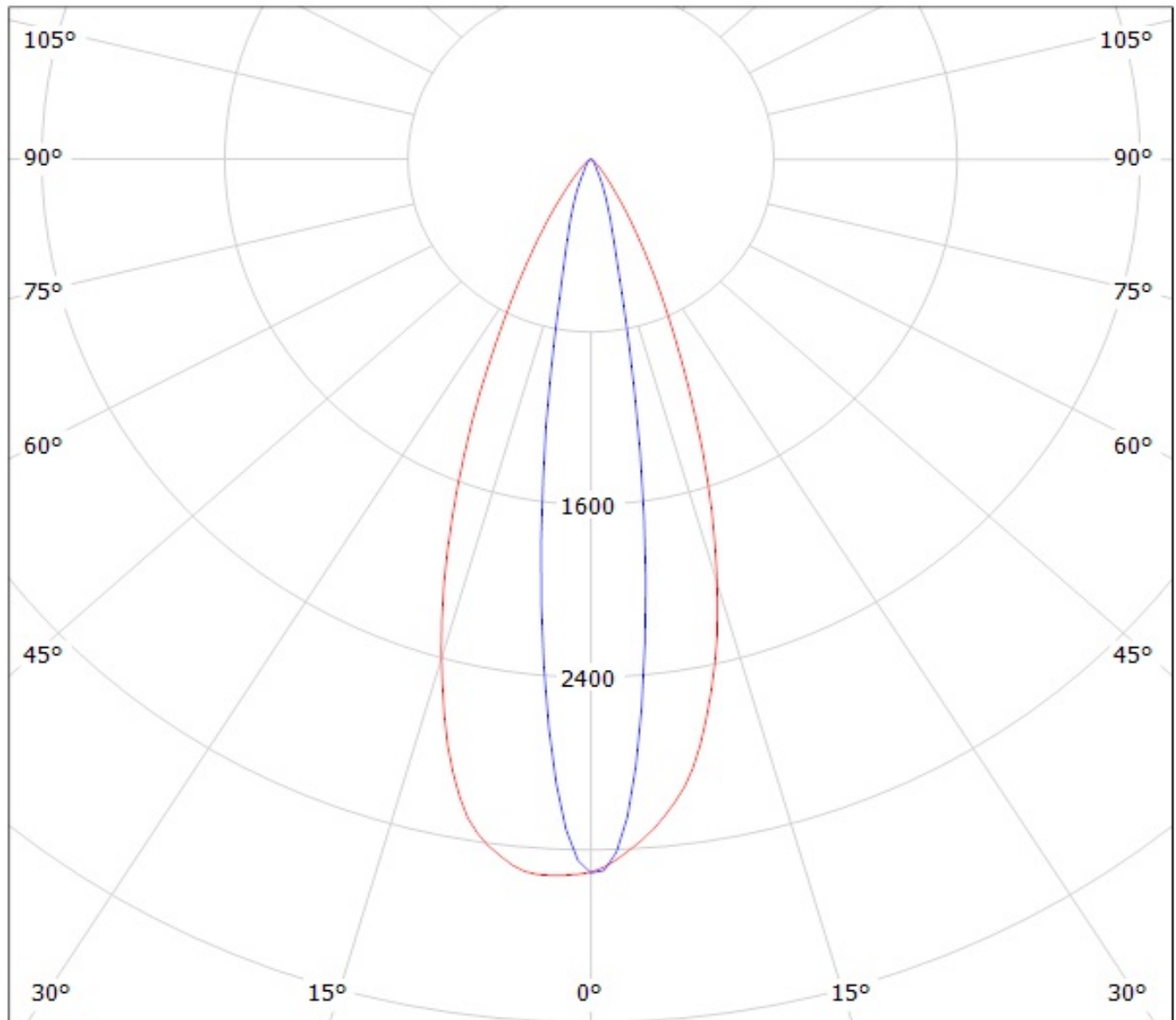

cd/klm

— C0 - C180

— C90 - C270

Luminaire: LEDIL OY CA12859_EVA-O / CP12860_EVA-O (XM-L) Efficiency=86%
Lamps: 1 x Cree XM-L (111lm @ 250mA)

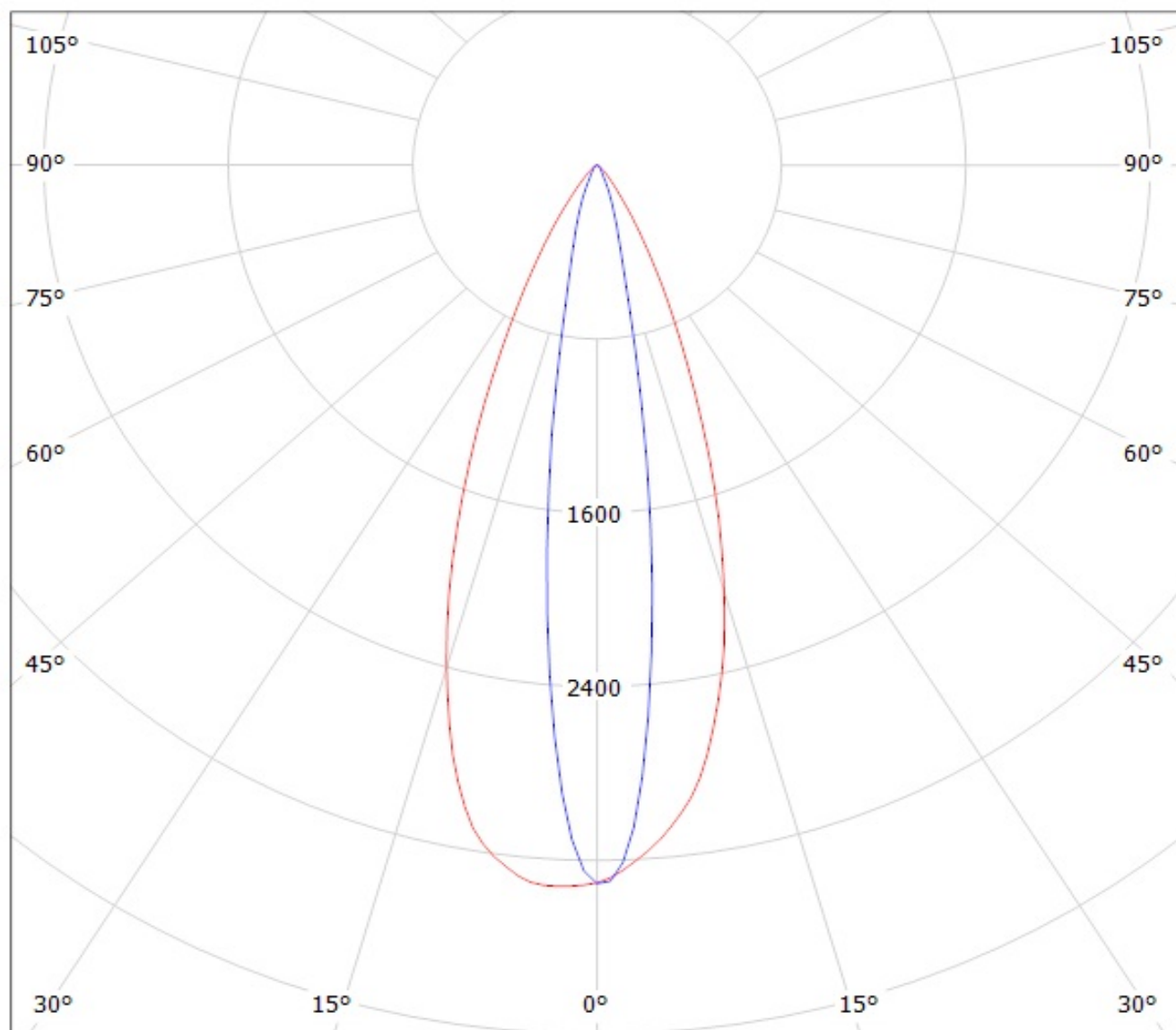

cd/klm

— C0 - C180

— C90 - C270

Luminaire: LEDIL OY CA12859_EVA-O / CP12860_EVA-O (XM-L) Efficiency=86%
Lamps: 1 x Cree XM-L (1111lm @ 250mA)

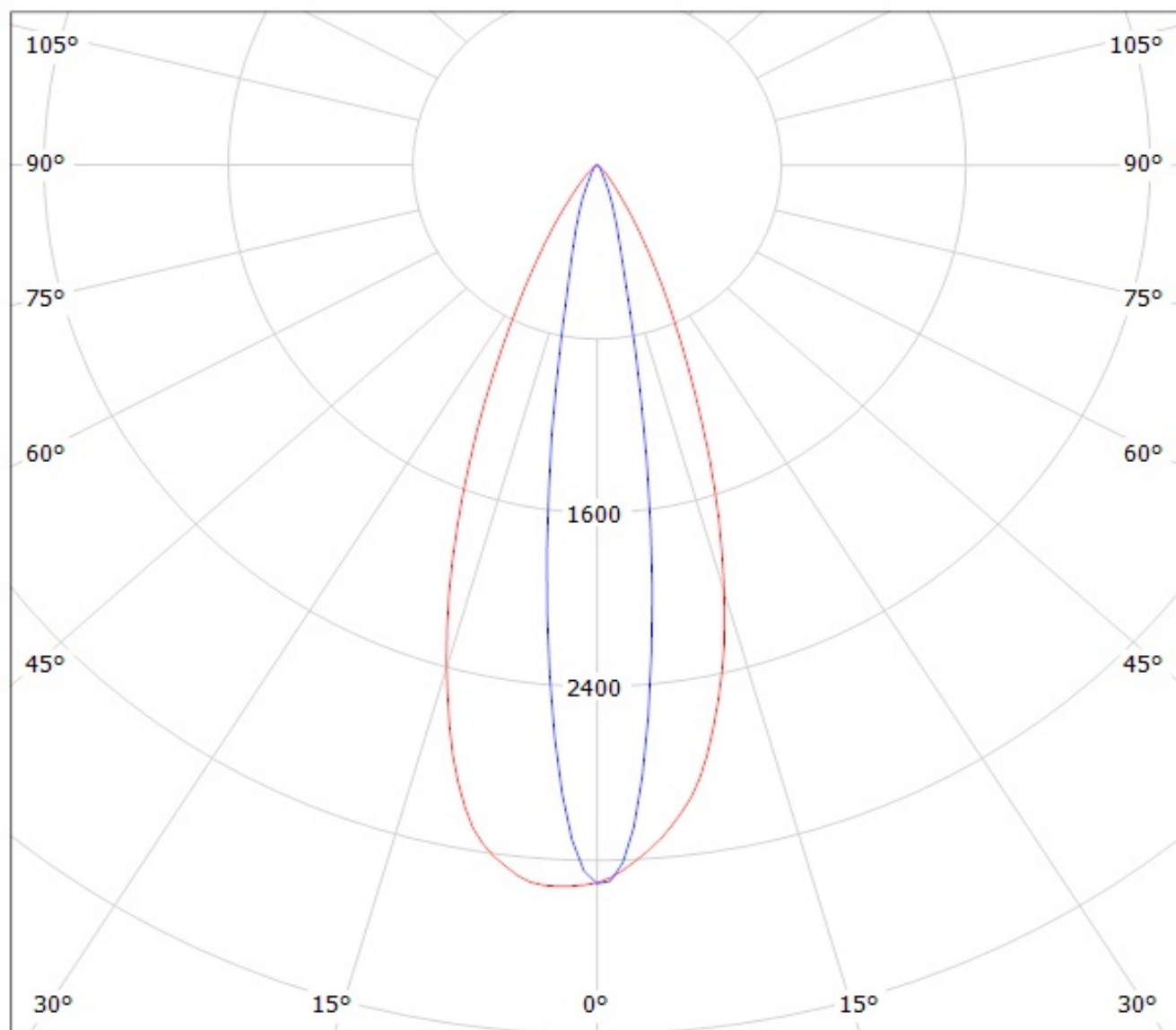

cd/klm

— C0 - C180

— C90 - C270

Ledil CA12055_Eva-S-XM-Tape CA12055_Eva-S-XM-Tape / LDC (Polar)

Luminaire: Ledil CA12055_Eva-S-XM-Tape CA12055_Eva-S-XM-Tape

Lamps: 1 x LED Module

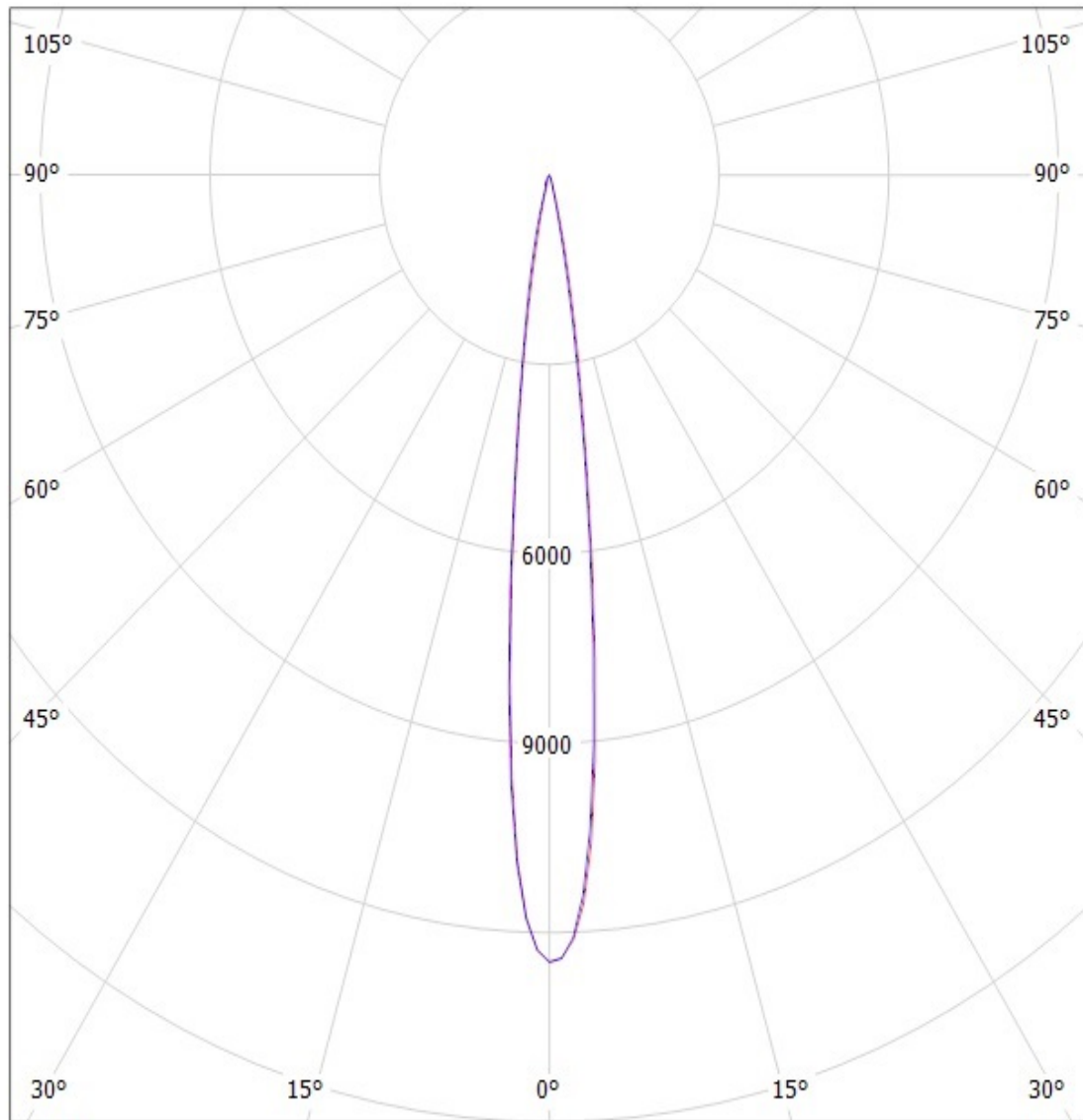

cd/klm

— C0 - C180 — C90 - C270

SIMULATED

Ledil CA12055_Eva-S-XM-Tape CA12055_Eva-S-XM-Tape / LDC (Polar)

Luminaire: Ledil CA12055_Eva-S-XM-Tape CA12055_Eva-S-XM-Tape

Lamps: 1 x LED Module

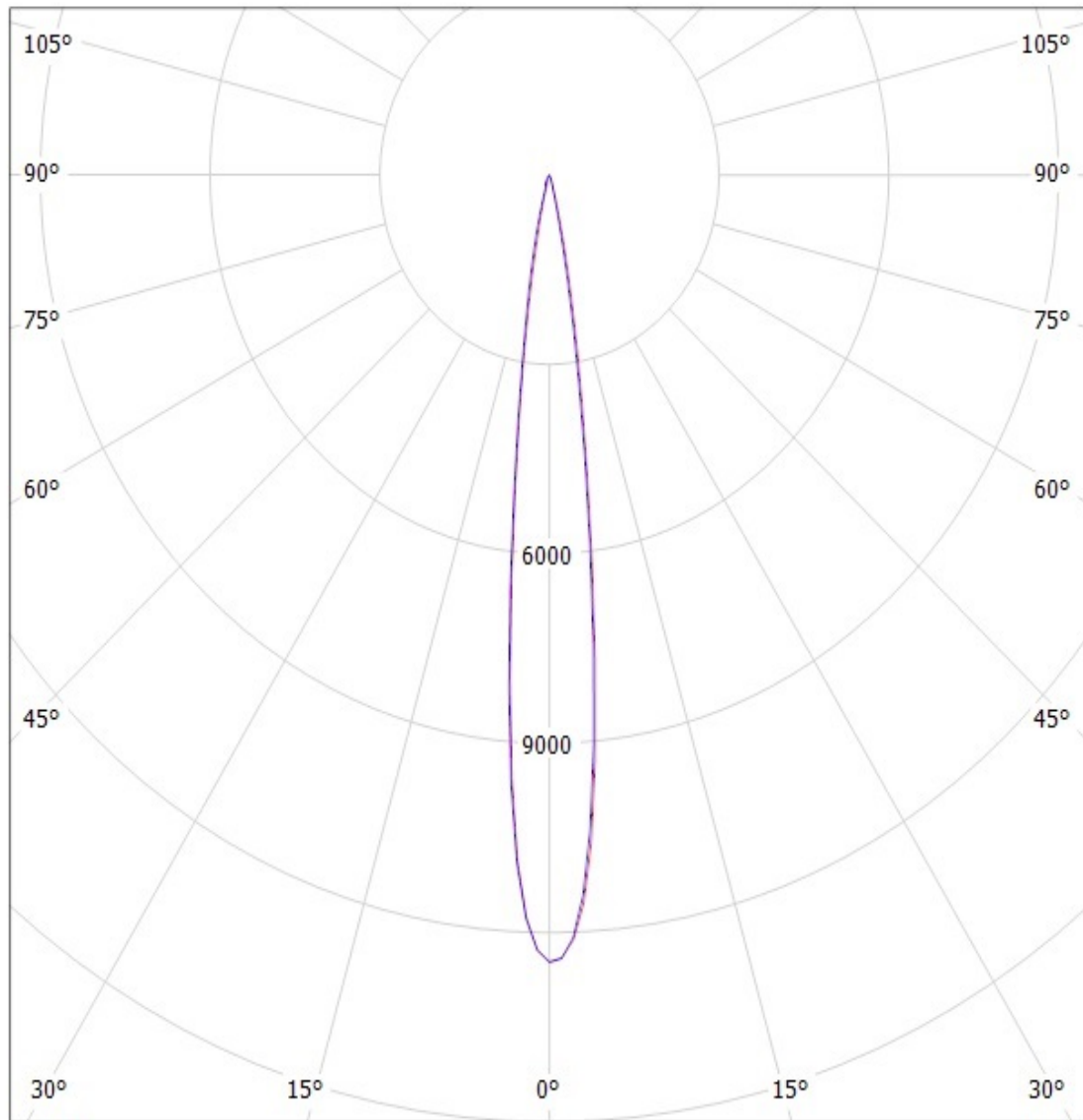

cd/klm

SIMULATED

— C0 - C180 — C90 - C270

Ledil Oy CA12059_Eva-W-XM-Tape CA12059_Eva-W-XM-Tape / LDC (Polar)

Luminaire: Ledil Oy CA12059_Eva-W-XM-Tape CA12059_Eva-W-XM-Tape

Lamps: 1 x Cree XM-L white

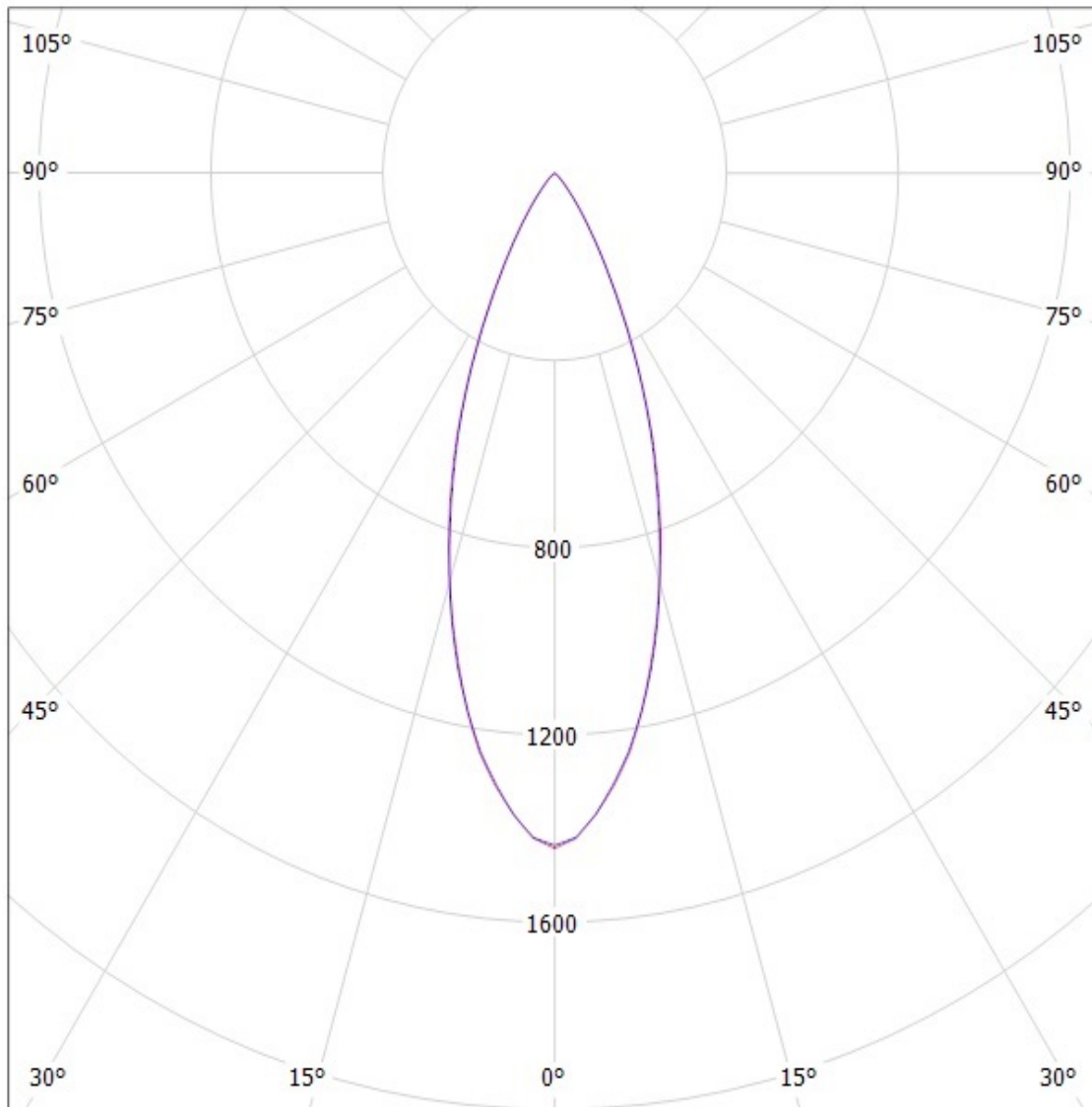

cd/klm

— C0 - C180

— C90 - C270

SIMULATED

Ledil Oy C10909_CA12060_Eva-WW-XM-Tape C10909_CA12060_Eva-WW-XM-Tape / LDC (Polar)

Luminaire: Ledil Oy C10909_CA12060_Eva-WW-XM-Tape C10909_CA12060_Eva-WW-XM-Tape

Lamps: 1 x Cree XM-L

