

Standstill Monitoring Unit

G9SX-SM

Sensor-less Monitoring of Standstill for Machines with Long Inertia

- Standstill is monitored by the motor's back electromotive force (BEMF) signal.
- Features a "Standard Configuration", allowing immediate use without sensitivity adjustment.
- "User Configuration" also available for fine-tuning of sensitivity.
- Detailed LED indications enable easy fault diagnosis.
- Safety Category 4 (EN954-1), PLe(ISO13849-1), SIL 3 (IEC/EN 62061) certified.

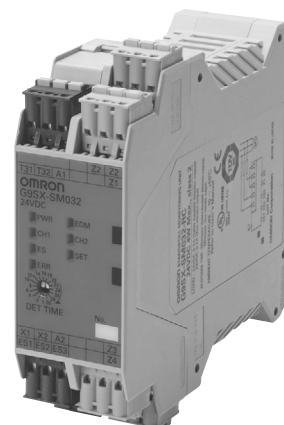

NEW



Be sure to read the "Precautions" on page 17.

Model Number Structure

Model Number Legend

G9SX- -

1 2 3 4 5

1. Functions

SM: Standstill Monitoring Unit

2. Output Configuration (Safety Outputs)

0: None

3. Output Configuration (Safety standstill detection outputs)

3: 3 outputs

4. Output Configuration (Auxiliary Outputs)

2: 2 outputs

5. Terminal block type

RT: Screw terminals

RC: Spring-cage terminals

List of Models

Standstill Monitoring Unit

Safety outputs	Safety standstill detection output	Auxiliary output	Rated voltage	Terminal block type	Model
--	3	2	24 VDC	Screw terminals	G9SX-SM032-RT
				Spring-cage terminals	G9SX-SM032-RC

G9SX-SM

Specifications

Ratings

Power input

Item	Model	G9SX-SM032-□
Rated supply voltage		24 VDC
Operating voltage range		-15% to 10% of rated supply voltage
Power consumption *		4 W max.

* Power consumption of loads not included.

Inputs

Item	Model	G9SX-SM032-□
Rated Input voltage		Standstill detection input (between Z1 and Z2 and between Z3 and Z4) *1 480 VAC max. (120Hz max.) *2
Internal impedance		Standstill detection input: Approx. 660 kΩ EDM input: Approx. 2.8 kΩ *3

*1. Input the motor phase-to-phase voltage between Z1 and Z2 and between Z3 and Z4.

*2. When a motor with AC240V or more is used, connect neutral point of the power supply to earth.

*3. Use a contact that is applicable to microloads (24 VDC, 5 mA) for connection to the EDM input.

Outputs

Item	Model	G9SX-SM032-□
Safety standstill detection output *1		Source output (PNP), load current: 0.3 A DC max. *2
Auxiliary output (output monitor/error)		Source output (PNP), load current: 100 mA DC max.

*1. While safety standstill detection outputs are in the ON state, the following pulse signal is output continuously for output circuit diagnosis.

When using the safety standstill detection outputs as input signals to control devices (i.e. Programmable Controllers), consider the pulse signal shown below.

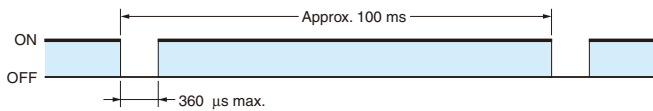

*2. The following derating is required when Units are mounted side-by-side.

G9SX-SM032-□: 0.2 A max. load current

Characteristics

Item	Model	G9SX-SM032-□
Over-voltage category (IEC/EN 60664-1)		III
Response time (Standstill detection ON to OFF)		50 ms max.
Detection voltage (Standstill detection voltage)		Standard Configuration: 10 mV max. User Configuration: 100 mV max.
ON-state residual voltage		3.0 V max. (Safety standstill detection outputs and auxiliary outputs)
OFF-state leakage current		0.1 mA max. (Safety standstill detection outputs and Auxiliary outputs)
Maximum cable length for standstill detection inputs and EDM inputs		100 m max. (External connection impedance: 100 Ω max. and 10 nF max.)
Insulation resistance	Between standstill detection inputs (Z1,Z2↔Z3,Z4)	100 MΩ min., 500 VDC megger
	Between standstill detection input terminals connected together and other input and output terminals connected together	
	Between all terminals without standstill detection input terminals connected together and DIN rail	
	Between standstill detection input terminals connected together and DIN rail.	
Dielectric strength	Between standstill detection inputs (Z1,Z2↔Z3,Z4)	2,000 VAC for 1 min.
	Between standstill detection input terminals connected together and Power supply input terminals and other input and output terminals connected together	2,200 VAC for 1 min.
	Between all terminals without standstill detection input terminals connected together and DIN rail	500 VAC for 1 min.
	Between standstill detection input terminals connected together and DIN rail.	2,200 VAC for 1 min.
Vibration resistance		Frequency: 10 to 55 to 10 Hz, 0.375-mm single amplitude (0.75-mm double amplitude)
Mechanical shock resistance	Destruction	300 m/s ²
	Malfunction	100 m/s ²
Ambient temperature		-10 to +55 °C (no icing or condensation)
Ambient humidity		25% to 85%
Degree of protection		Terminal block : IP20, Main body : IP40
Terminal tightening torque *		0.6N·m
Weight		Approx. 200 g

* For G9SX-SM032-RT (with screw terminals)

G9SX-SM

Connections

Internal Connection

G9SX-SM032-□(Standstill Monitoring Unit)

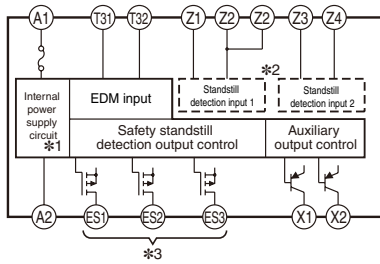

*1. Internal power supply circuit is not isolated.

*2. Standstill detection inputs are isolated respectively.

*3. The Safety standstill detection outputs, ES1 - ES3, are internally redundant respectively.

Wiring of inputs and outputs

Signal Name	Terminal Name	Description of operation	Wiring
Power supply input	A1,A2	Power supply input for G9SX-SM□. Connect the power source to the A1 and A2 terminals.	Connect the power supply plus to the A1 terminal. Connect the power supply minus to the A2 terminal.
Standstill detection input 1	Z1,Z2	To turn on the Safety standstill detection outputs, both standstill detection inputs must be below the threshold voltage. Otherwise, Safety standstill detection outputs will NOT be turned ON.	Connect Z1 and Z2 to the motor lines respectively.
Standstill detection input 2	Z3,Z4	When the wiring between the motor and G9SX-SM□ breaks, G9SX-SM□ detects it as failure of the wiring or continues to operated as motor is rotating, regardless of the status of motor. Thus the breakage of wiring does not lead to a dangerous situation.	Connect Z3 and Z4 to the motor lines respectively.
EDM input	T31,T32	To turn on safety standstill detection outputs, ON-state signals should be input to T32. Otherwise, Safety standstill detection outputs will not be turned ON.	Corresponds to category 3
			Corresponds to category 4
Safety standstill detection output	ES1,ES2,ES3	Turns ON/OFF according to the state of standstill detection inputs and EDM input.	Keep these outputs Open when NOT used.
Auxiliary output (Monitor)	X1	Outputs a signal while the motor is determined as in a standstill condition.	Keep these outputs Open when NOT used.
Auxiliary output (Error)	X2	Turns ON when the error indicator is blinking or lit.	Keep these outputs Open when NOT used.

* For protecting the motor against short-circuit due to incorrect wiring, etc., apply overcurrent protective equipment: fuses, circuit-breaker, etc., with the ratings below.

Rated voltage: Greater than standstill detection inputs
(voltage supplied to the motor)

Rated current: 3A max.

Functions

Configuration and Mode

Use the "Operation Preset switch" on the back side to select either Standard Configuration or User Configuration. The selected configuration mode is enabled at power-on. Normally, please use Standard Configuration which is set as factory default. If the standstill determining time is found too long in the Standard Configuration mode, switch to User Configuration and adjust the standstill determining time.

Standard Configuration

When G9SX-SM detects that the standstill detection input voltage is 10 mV or less, it will turn on safety standstill detection outputs, determining the motor is in a standstill condition.

In Standard Configuration, any settings with the Mode preset switch on the back of the unit and both of the Standstill determining time preset switches on the front and on the back of the unit are disabled.

User Configuration

When G9SX-SM detects that the standstill detection input voltage has been 100 mV or less for a predetermined standstill determining time or longer, or when G9SX-SM detects that the standstill detection input voltage has been 10mV or less, it will turn ON safety standstill detection outputs, determining the motor is in a standstill condition.

In User Configuration, two modes are available: Tuning mode (TUN) and Monitoring Mode (MON). Either can be selected by setting the "Mode Preset switch".

The selected mode is applied at power-on.

Mode name	Function	Operation
Tuning Mode	Use this mode to adjust the standstill determining time. This mode is only for adjusting the standstill determining time. *	To preset the standstill determining time, use the "DET TIME switch (the standstill determining time preset switch)" on the front side. Once the DET TIME setting is changed, the new setting immediately comes into effect on the system without having to perform a power cycle. When a standstill condition is detected, the auxiliary monitor output is turned ON and the ES Indicator is lit, but safety standstill detection outputs are NOT turned ON.
Monitoring Mode	Use this mode in normal operation after the Standstill determining time is fixed.	In this mode, G9SX-SM operation depends on the "DET TIME switches (the standstill determining time preset switches)", one each on the front side and the back side. The DET TIME (standstill determining time) setting values come into effect at power on.

* If the optimal standstill determining time is already known, the value can be applied to the Monitoring Mode, without having to use the Tuning Mode.

Operation Preset switch/Mode Preset switch

Use switches on the back side of the unit for operation preset and mode preset.

Manipulation of preset switches must be done while the power is off.

Name	Function	Configuration
Configuration Preset Switch	Selects either Standard configuration or User configuration	STD (Standard Configuration: default setting)/USR (User Configuration)
ModePreset Switch	Selects either Tuning mode or Monitoring mode in User configuration.	MON(Monitoring Mode : default setting)/TUN(Tuning Mode)

Note: The preset switch setting comes into effect at power on.

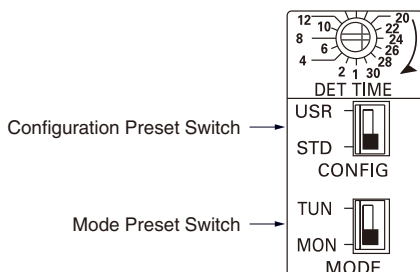

Standstill Determining Time Preset Switch

Presets the standstill determining time in User Configuration. Configuration is made through switches on the front and back side of the unit. Operation can be normal only if both switch values are the same. If the values are different, an error occurs.

Name	Function	Configuration
Standstill determining time preset switch	Presets the standstill determining time in User Configuration	1/2/4/6/8/10/12/14/16/18/20/22/24/26/28/30(Factory shipment)(s)

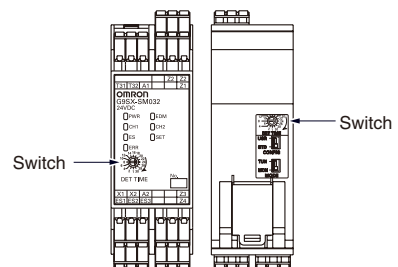

See the illustration below for setting the standstill determining time preset switches. Make sure that the direction of cutting edge of preset switch is correctly pointed to the determining time value which must be set.

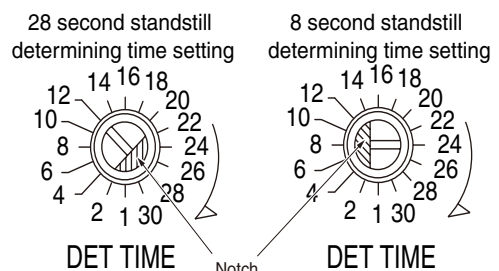

Functions

Standard Configuration

"Standard Configuration" allows standstill detection without tuning sensitivity.

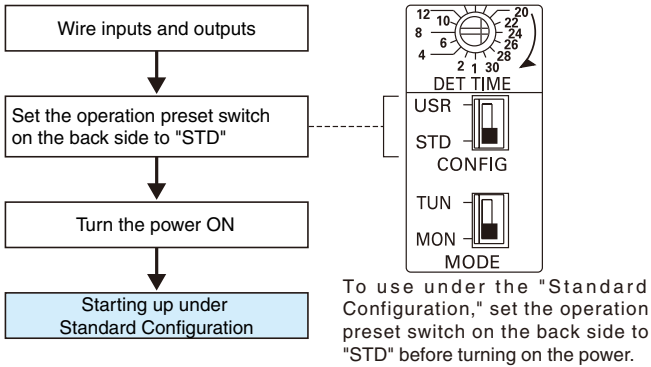

User Configuration

"User Configuration" allows manual tuning to adjust sensitivity. User Configuration has Tuning Mode to tune sensitivity and Monitoring Mode to detect the standstill condition.

(1) Start up under the Tuning Mode

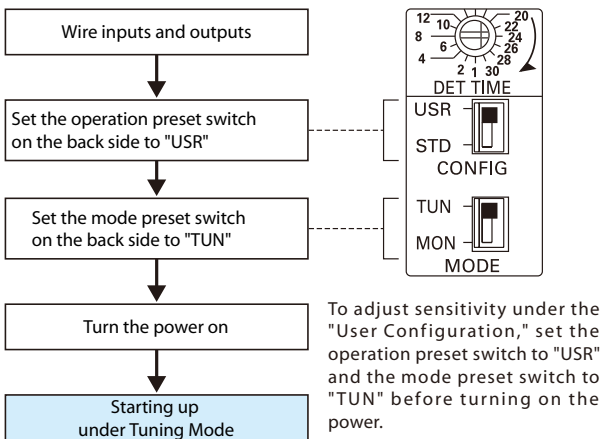

(2) Adjust sensitivity

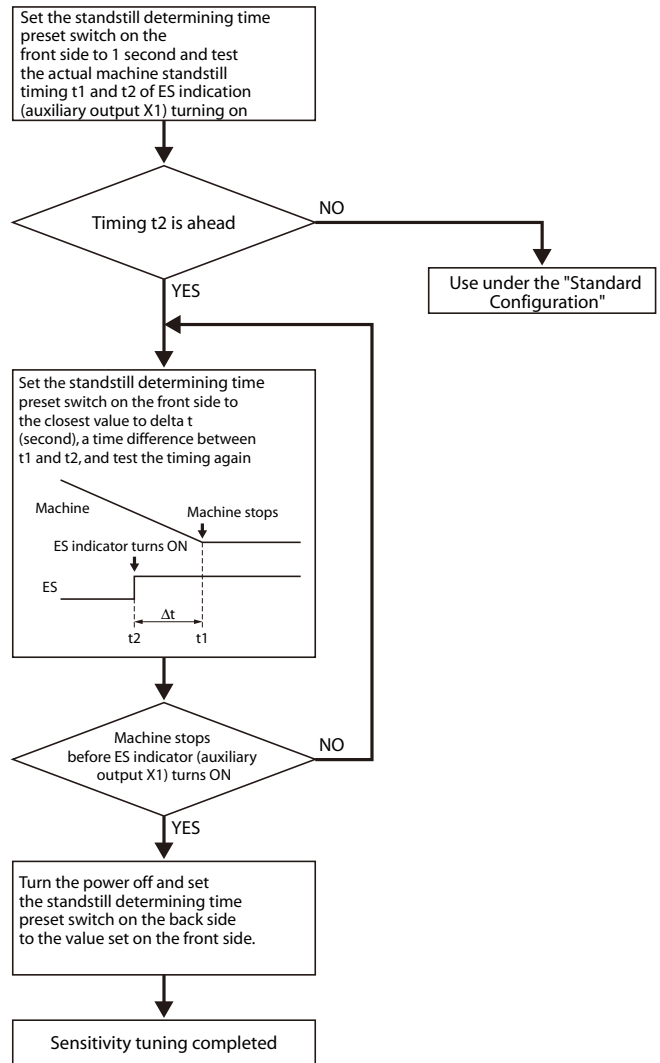

(3) Monitor under the User Configuration

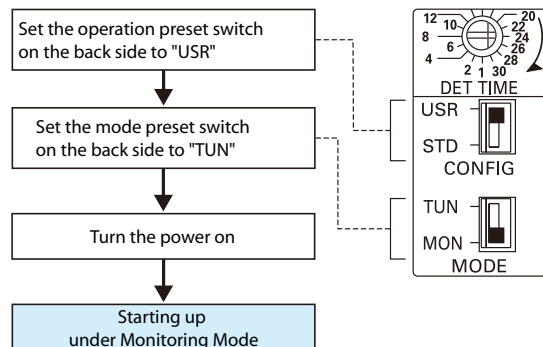

LED Indicators

Marking	Color	Name	Function
PWR	Green	Power supply indicator	Lights up while power is supplied.
EDM	Orange	EDM input indicator	Lights up while a HIGH state signal is input to T32. Blinks when error relating to EDM (External Device Monitoring) input occurs.
CH1	Orange	Standstill detection input ch1 indicator	Lights up while the standstill detection input voltage between Z1 and Z2 is below the threshold voltage. Blinks when an error relating to standstill detection input ch1 occurs. *
CH2	Orange	Standstill detection input ch2 indicator	Lights up while the standstill detection input voltage between Z3 and Z4 is below the threshold voltage. Blinks when an error relating to standstill detection input ch2 occurs. *
ES	Orange	Safety standstill detection output indicator	Lights up while the Safety standstill detection outputs (ES1, ES2, ES3) are in the ON-state. Blinks when an error relating to the Safety standstill detection input occurs. *
SET	Orange	Setting indicator	Depending on the status of operation preset switch and mode preset switch. See below for details. Standard Configuration: Turns OFF Tuning Mode in User Configuration: Blinks Monitoring Mode in User Configuration: Lights up Blinks when an error relating the selected configuration mode occurs. *
ERR	Red	Error indicator	Lights up or blinks depending on the occurring error *

* Refer to "Fault Detection" on the next page for details

Settings indication (at power ON)

Settings for G9SX-LM□ can be checked by indicators for approx. 3 seconds after power on. During the settings indication term, ERR indicator will light up, however the auxiliary error output will remain off.

Indicator	Item	Indicator status	Setting mode	Setting status
SET	Standard/User Configuration	Not lit	Standard Configuration	STD
		Light up	User Configuration	USR

Fault Detection

When the G9SX-SM□ detects a fault, the ERR indicator and/or other indicators light up or blink to inform the user about the fault. Take actions based on the table shown below. After the action, turn the power on again.

EER indicator	Other indicator	Fault	Expected causes of the fault	Checking points and measures to take
	--	Fault by electro-magnetic disturbance or of internal circuits.	1) Excessive electro-magnetic disturbance 2) Failure of the internal circuit	1) Check the disturbance level around G9SX-SM and its related system. 2) Replace with a new product.
	CH1 blinks	Faults involved with Standstill detection input 1	1) Failure involving the wiring of standstill detection input 1 2) Inverter dynamic brake setting 3) Failure of the circuit of standstill detection input 1	1) Check the wiring to Z1 and Z2. 2) Set the brake time at less than 30 seconds. 3) Replace with a new product.
	CH2 blinks	Faults involved with Standstill detection input 2	1) Failure involving the wiring of standstill detection input 2 2) Inverter dynamic brake setting 3) Failure of the circuit of standstill detection input 2	1) Check the wiring to Z3 and Z4. 2) Set the brake time at less than 30 seconds. 3) Replace with a new product.
	CH1 and CH2 Blink at once	Faults involved with Standstill detection input	1) Frequency of standstill detection input is out range.	1) Confirm the operation frequency of the motor is 120Hz or less.
	EDM blinks	Faults involved with EDM input	1) Failure involving the wiring of EDM input 2) Excessive electro-magnetic disturbance 3) Failure of the circuit of the EDM input	1) Check the wiring to T31 and T32 2) Separately wire to T31 and T32 from the power line etc. of the inverter. 3) Replace with a new product.
	ES blinks	Faults involved with Safety Standstill detection outputs	1) Failure involving the wiring of Safety standstill detection outputs 2) Excessive electro-magnetic disturbance 3) Failure of the circuit of Safety standstill detection outputs 4) Impermissible high ambient temperature	1) Check the wiring to ES1, ES2 and ES3 2) Separately wire to ES1, ES2 and ES3 from the power line etc. of the inverter. 3) Replace with a new product. 4) Check the ambient temperature and spacing around G9SX-SM.
	SET blinks	Faults involved with Operation mode settings	1) Incorrect set values of Standstill determining time preset switches. 2) Failure of the circuit of mode settings	1) Check the set values of the two of Standstill determining time preset switches. 2) Replace with a new product.
	The All (without PWR) indicators blink	Supply voltage outside the rated value	1) Supply voltage outside the rated value	1) Check the supply voltage to G9SX units.

When some indicators blink except ERR indicator, check and take needed actions referring to the following table.

EER indicator	Other indicator	Fault	Expected causes of the fault	Checking points and measures to take
	SET blinks	Tuning Mode operation	Operating Mode is in Tuning Mode of User Configuration.	Check if the Operation preset switch and the Mode preset switch on the back side are properly set. In the User Configuration Mode, safety standstill detection outputs will NOT be turned ON.

Dimensions and Terminal Arrangement

(unit: mm)

Standstill Monitoring Unit G9SX-SM032-□

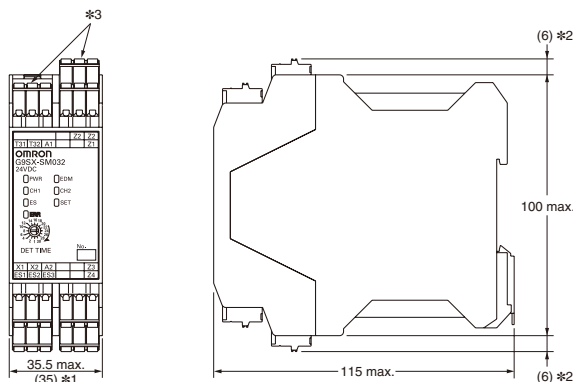
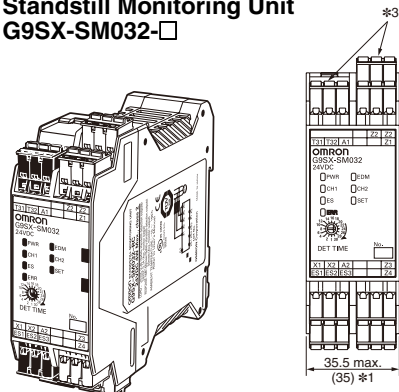

*1. Typical dimension
*2. For -RC terminal type only.
*3. The terminal colors are green for the Unit right side (Standstill detection input) and black for the left side.

Terminal arrangement

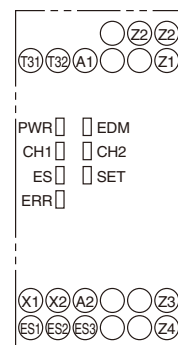

Note: Above outline drawing is for -RC terminal type.

Application Examples

G9SX-SM032 (24 VDC) (3-phase Induction Motor)

+ G9SX-AD322-T15 (24 VDC)

(Guard Lock Safety Door Switch, 2-channel Safety Limit Switch Inputs/Manual Reset)

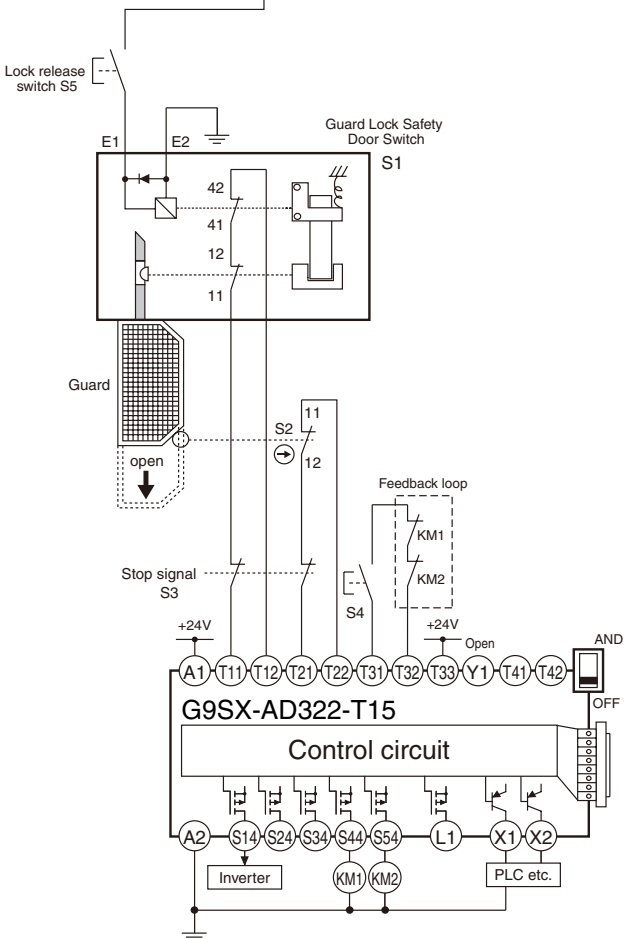
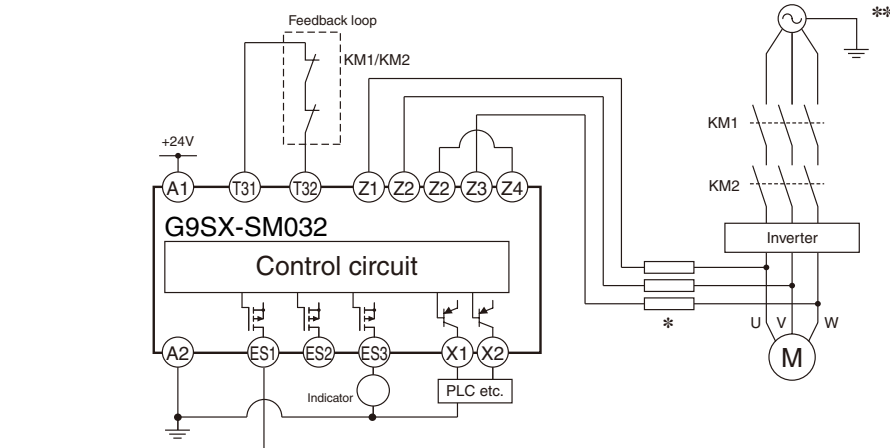

- S1: Guard Lock Safety Door Switch
- S2: Safety limit switch
- S3: Stop signal
- S4: Reset switch
- S5: Lock release switch
- KM1, KM2: Contactor
- M: 3-phase induction motor

Timing Chart

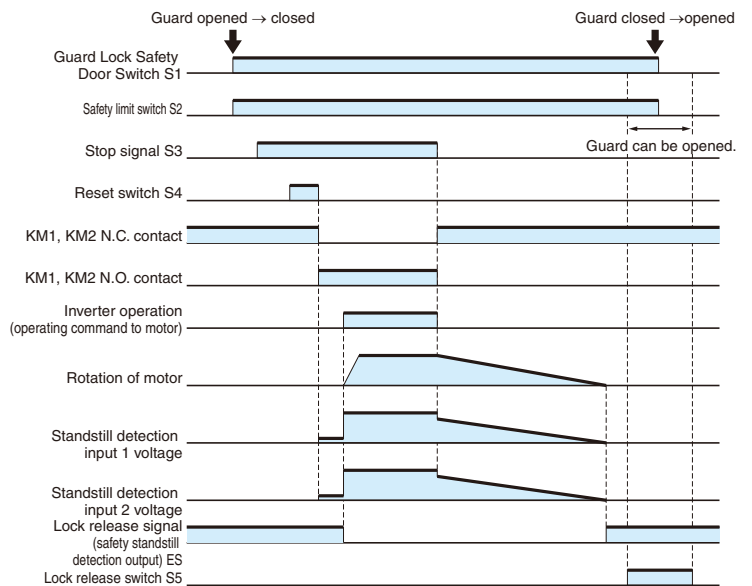

Note: This circuit example is equivalent to Safety Category 4 (Stop Category 1).

For details, see "Safety Category (EN954-1, ISO13849-1)".

* For protecting the motor against short-circuit due to incorrect wiring, etc., apply overcurrent protective equipment: fuses, circuit-breaker, etc., with the ratings below.

Rated voltage: Greater than standstill detection inputs (voltage supplied to the motor)

Rated current: 3A max.

** When a motor with AC240V or more is used, connect neutral point of the power supply to earth.

G9SX-SM

G9SX-SM032 (24 VDC) (3-phase Induction Motor)
+ G9SX-BC202 (24 VDC) (2-channel Emergency Stop Switch Inputs/Manual Reset)
+ G9SX-GS226-T15 (24 VDC)
(Guard Lock Safety Door Switch + 2-channel Safety Limit Switch Inputs/Manual Reset)

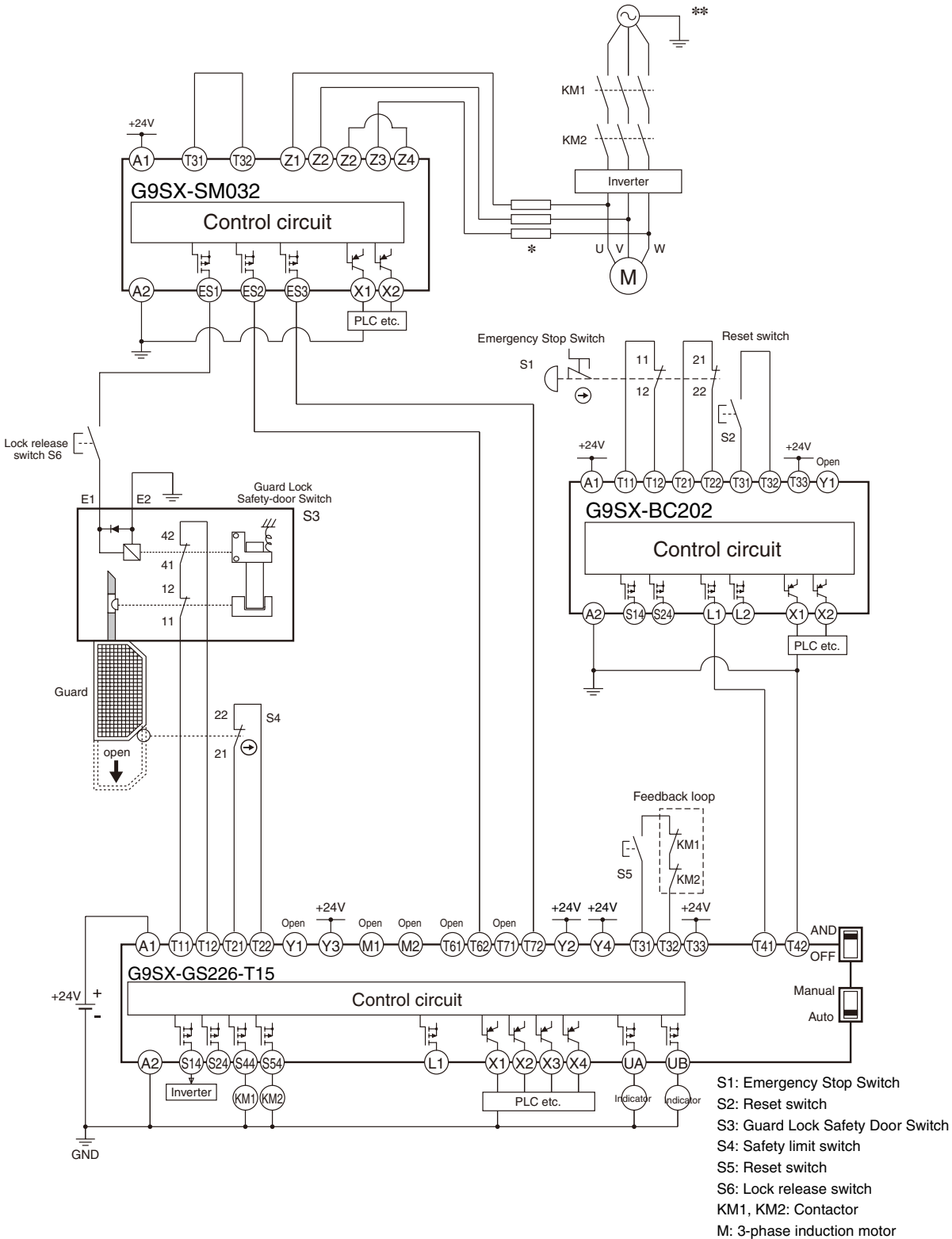

Note: 1. This circuit example is equivalent to Safety Category 3 (Stop Category 2). For details, see "Safety Category (EN954-1, ISO13849-1)".
 2. Power for the inverter is cut when the motor rotation is detected in this system with a guard open. Its response time is an accumulation of G9SX-SM and G9SX-GS. Determine a safety distance to hazards in view of this response time.

* For protecting the motor against short-circuit due to incorrect wiring, etc., apply overcurrent protective equipment: fuses, circuit-breaker, etc., with the ratings below.
 Rated voltage: Greater than standstill detection inputs (voltage supplied to the motor)
 Rated current: 3A max.
 ** When a motor with AC240V or more is used, connect neutral point of the power supply to earth.

Timing Chart

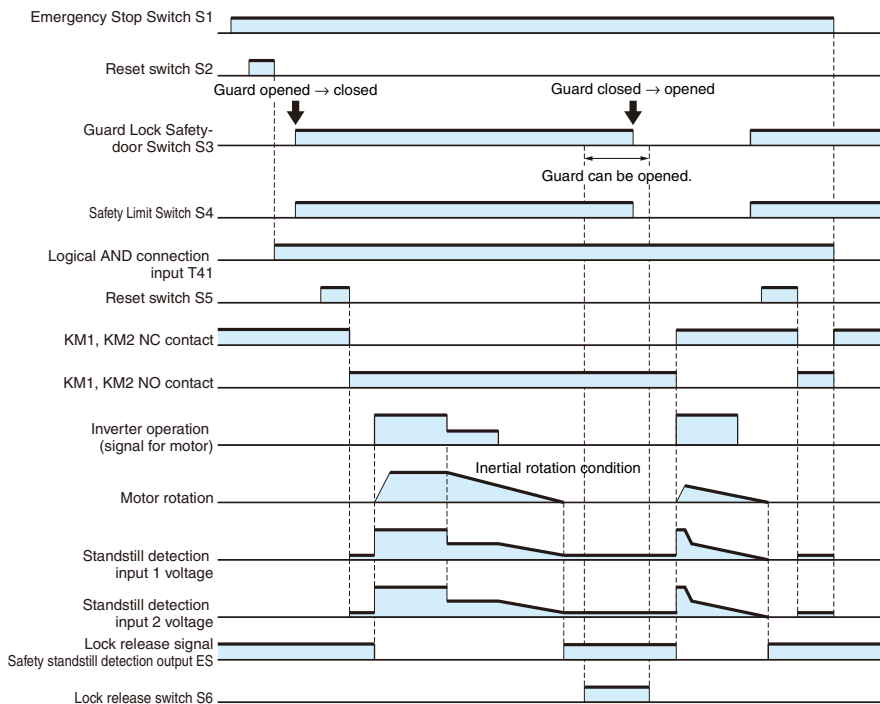

G9SX-SM

**G9SX-SM032 (24 VDC) (3-phase Induction Motor with Star-Delta wiring)
+ G9SX-BC202 (24 VDC)
(Guard Lock Safety Door Switch + 2-channel Safety Limit Switch inputs/Manual Reset)**

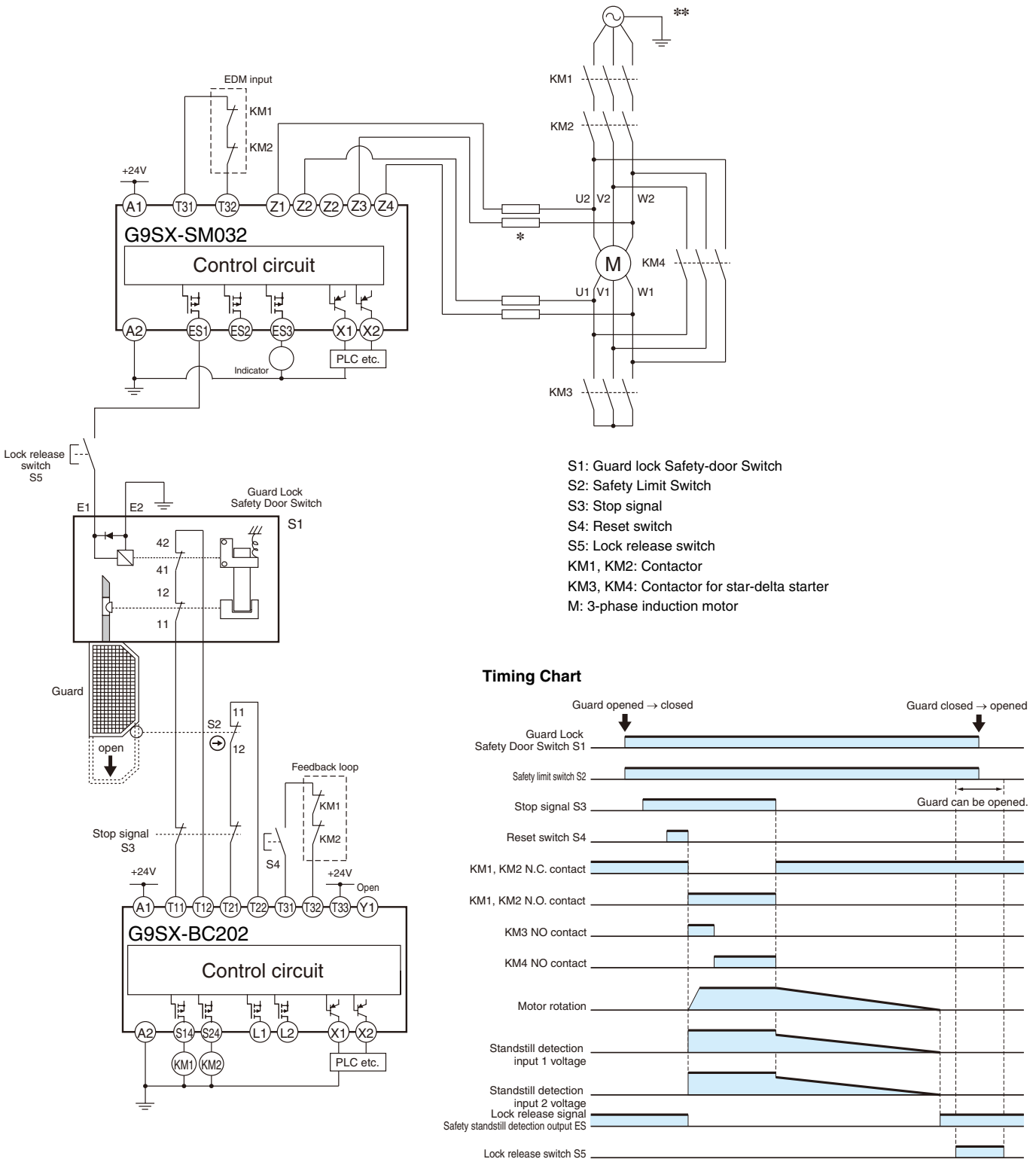





Note: This circuit example is equivalent to Safety Category 4 (Stop Category 0).
For details, see "Safety Category (EN954-1, ISO13849-1)".

* For protecting the motor against short-circuit due to incorrect wiring, etc., apply overcurrent protective equipment: fuses, circuit-breaker, etc., with the ratings below.
Rated voltage: Greater than standstill detection inputs (voltage supplied to the motor)
Rated current: 3A max.

** When a motor with AC240V or more is used, connect neutral point of the power supply to earth.

Operational procedure





Standard Configuration

Operation			LED indicator	Machine operation	ES output	X1 output
Wire inputs and outputs	Set the operation preset switch on the back side to "STD"		--		--	--
Turn the power ON	Initial configuration display	<input type="checkbox"/> PWR <input type="checkbox"/> EDM <input type="checkbox"/> CH1 <input type="checkbox"/> CH2 <input type="checkbox"/> ES <input type="checkbox"/> SET <input type="checkbox"/> ERR		Standstill	OFF	OFF
	Monitoring starts	<input type="checkbox"/> PWR <input type="checkbox"/> EDM <input type="checkbox"/> CH1 <input type="checkbox"/> CH2 <input type="checkbox"/> ES <input type="checkbox"/> SET <input type="checkbox"/> ERR			ON	ON
Machine operation	Rotation is detected and ES turns OFF	<input type="checkbox"/> PWR <input type="checkbox"/> EDM <input type="checkbox"/> CH1 <input type="checkbox"/> CH2 <input type="checkbox"/> ES <input type="checkbox"/> SET <input type="checkbox"/> ERR		Rotating	OFF	OFF
Stop command	Decelerating	<input type="checkbox"/> PWR <input type="checkbox"/> EDM <input type="checkbox"/> CH1 <input type="checkbox"/> CH2 <input type="checkbox"/> ES <input type="checkbox"/> SET <input type="checkbox"/> ERR				
	Standstill is detected and ES turns ON	<input type="checkbox"/> PWR <input type="checkbox"/> EDM <input type="checkbox"/> CH1 <input type="checkbox"/> CH2 <input type="checkbox"/> ES <input type="checkbox"/> SET <input type="checkbox"/> ERR		Standstill	ON	ON

Note: LED indication is based on wiring equivalent to safety category 4. For wiring equivalent to category 3, EDM lights up even during the machine operation.

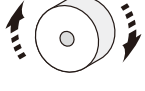
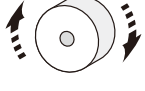

User Configuration

Tuning Mode

Operation			LED indicator	Machine operation	ES output	X1 output
Wire inputs and outputs	Set the operation preset switch on the back side to "USR"	 USR STD CONFIG	--	Standstill 	--	--
	Set the mode preset switch on the back side to "TUN"	 TUN MON MODE				
	Set the standstill determining time preset switch on the front side to 1 second	 DET TIME				
Turn the power ON	Initial configuration display	<input type="checkbox"/> PWR <input type="checkbox"/> EDM <input type="checkbox"/> CH1 <input type="checkbox"/> CH2 <input type="checkbox"/> ES <input type="checkbox"/> SET <input type="checkbox"/> ERR	<input type="checkbox"/> PWR <input type="checkbox"/> EDM <input type="checkbox"/> CH1 <input type="checkbox"/> CH2 <input type="checkbox"/> ES <input checked="" type="checkbox"/> SET <input type="checkbox"/> ERR		OFF	OFF
	Tuning starts	<input type="checkbox"/> PWR <input type="checkbox"/> EDM <input type="checkbox"/> CH1 <input type="checkbox"/> CH2 <input type="checkbox"/> ES <input checked="" type="checkbox"/> SET <input type="checkbox"/> ERR				
Machine trial run	Rotation is detected and CH1/CH2/ES turn OFF (Auxiliary output X1 turns OFF)	<input type="checkbox"/> PWR <input type="checkbox"/> EDM <input type="checkbox"/> CH1 <input type="checkbox"/> CH2 <input type="checkbox"/> ES <input checked="" type="checkbox"/> SET <input type="checkbox"/> ERR	<input type="checkbox"/> PWR <input type="checkbox"/> EDM <input type="checkbox"/> CH1 <input type="checkbox"/> CH2 <input type="checkbox"/> ES <input checked="" type="checkbox"/> SET <input type="checkbox"/> ERR		OFF	OFF
Stop command	CH1/CH2/ES light up (Auxiliary output X1 turns ON)	<input type="checkbox"/> PWR <input type="checkbox"/> EDM <input type="checkbox"/> CH1 <input type="checkbox"/> CH2 <input type="checkbox"/> ES <input checked="" type="checkbox"/> SET <input type="checkbox"/> ERR	<input type="checkbox"/> PWR <input type="checkbox"/> EDM <input type="checkbox"/> CH1 <input type="checkbox"/> CH2 <input type="checkbox"/> ES <input checked="" type="checkbox"/> SET <input type="checkbox"/> ERR			
			<input type="checkbox"/> PWR <input type="checkbox"/> EDM <input type="checkbox"/> CH1 <input type="checkbox"/> CH2 <input type="checkbox"/> ES <input checked="" type="checkbox"/> SET <input type="checkbox"/> ERR	<input type="checkbox"/> PWR <input type="checkbox"/> EDM <input type="checkbox"/> CH1 <input type="checkbox"/> CH2 <input type="checkbox"/> ES <input checked="" type="checkbox"/> SET <input type="checkbox"/> ERR		

Note: LED indication is based on wiring equivalent to safety category 4. For wiring equivalent to category 3, EDM lights up even during the machine operation.

Tuning Mode (continued)

Operation	LED indicator	Machine operation	ES output	X1 output
Set the standstill determining time preset switch on the front side to T seconds	--	--	--	--
Machine trial run	<input type="checkbox"/> PWR <input type="checkbox"/> EDM <input type="checkbox"/> CH1 <input type="checkbox"/> CH2 <input type="checkbox"/> ES <input checked="" type="checkbox"/> SET <input type="checkbox"/> ERR	Rotating 	OFF	OFF
Stop command	<input type="checkbox"/> PWR <input type="checkbox"/> EDM <input type="checkbox"/> CH1 <input type="checkbox"/> CH2 <input type="checkbox"/> ES <input checked="" type="checkbox"/> SET <input type="checkbox"/> ERR	Decelerating 		
	CH1/CH2 light up	<input type="checkbox"/> PWR <input type="checkbox"/> EDM <input type="checkbox"/> CH1 <input type="checkbox"/> CH2 <input type="checkbox"/> ES <input checked="" type="checkbox"/> SET <input type="checkbox"/> ERR		
	ES lights up (auxiliary output X1 is ON)	<input type="checkbox"/> PWR <input type="checkbox"/> EDM <input type="checkbox"/> CH1 <input type="checkbox"/> CH2 <input type="checkbox"/> ES <input checked="" type="checkbox"/> SET <input type="checkbox"/> ERR	Standstill 	ON

Tuning completed

If ES lights up before the machine comes to standstill, set a larger DET time and repeat the procedure from machine trial run to stop command.

Note: LED indication is based on wiring equivalent to safety category 4. For wiring equivalent to category 3, EDM lights up even during the machine operation.

Monitoring Mode

Operation			LED indicator	Machine operation	ES output	X1 output	
Set the operation preset switch on the back side to "USR"		Set the standstill determining time preset switch on the back side to a setup value determined by the Tuning Mode	--	Standstill 	--	--	
Set the mode preset switch on the back side to "MON"							
Turn the power ON			Initial configuration display	<input type="checkbox"/> PWR <input type="checkbox"/> EDM <input type="checkbox"/> CH1 <input type="checkbox"/> CH2 <input type="checkbox"/> ES <input type="checkbox"/> SET <input type="checkbox"/> ERR		OFF	OFF
			Monitoring starts	<input type="checkbox"/> PWR <input type="checkbox"/> EDM <input type="checkbox"/> CH1 <input type="checkbox"/> CH2 <input type="checkbox"/> ES <input type="checkbox"/> SET <input type="checkbox"/> ERR		ON	ON
Machine operation			Rotation is detected and ES turns OFF	<input type="checkbox"/> PWR <input type="checkbox"/> EDM <input type="checkbox"/> CH1 <input type="checkbox"/> CH2 <input type="checkbox"/> ES <input type="checkbox"/> SET <input type="checkbox"/> ERR		OFF	OFF
Stop command			CH1/CH2 light up	<input type="checkbox"/> PWR <input type="checkbox"/> EDM <input type="checkbox"/> CH1 <input type="checkbox"/> CH2 <input type="checkbox"/> ES <input type="checkbox"/> SET <input type="checkbox"/> ERR			
			ES lights up after a specified DET time passed	<input type="checkbox"/> PWR <input type="checkbox"/> EDM <input type="checkbox"/> CH1 <input type="checkbox"/> CH2 <input type="checkbox"/> ES <input type="checkbox"/> SET <input type="checkbox"/> ERR			

Note: LED indication is based on wiring equivalent to safety category 4. For wiring equivalent to category 3, EDM lights up even during the machine operation.

Precautions

Warning

Serious injury may possibly occur due to breakdown of safety outputs.
Do not connect loads beyond the rated value to the safety outputs.



Serious injury may possibly occur due to loss of required safety functions.
Do not use G9SX-SM□ in the system where plurality of motors are driven by one inverter or contactor.



Serious injury may possibly occur due to loss of required safety functions.
Wire G9SX-SM□ properly so that supply voltages or voltages for loads do NOT touch the safety inputs accidentally or unintentionally.



Serious injury may possibly occur due to damages of safety inputs.
Apply protection circuitry against back electromotive force in case connecting inductive loads to safety outputs.



Serious injury may possibly occur due to loss of required safety functions.
Monitor a motor that operates on a commercial frequency (60 Hz) or lower.



Serious injury may possibly occur due to loss of safety functions.
Operate the motor at rated G9SX-SM□ input frequency (120Hz) or less.



Serious injury may possibly occur due to loss of safety functions.
Use devices appropriate for the application and the condition where G9SX-SM□ is used.



Control Devices	Requirements
Guard lock Safety-door Switch	Use certified devices with Direct Opening Mechanism complying with IEC/EN 60947-5-1 Use approved devices with Direct Opening Mechanism complying with IEC/EN 60947-5-1, mechanical lock type and capable of solenoid coil 24VDC, less than 300mA.
Safety Relay	Use certified devices with forcibly guided contacts complying with EN 50205. For feedback purpose use devices with contacts capable of switching micro loads of 24VDC, 5mA.
Contactors	Use contactors with forcibly guided mechanism to input the signal to Feedback/Reset input of G9SX-SM□ through the NC contact of the contactor. For feedback purpose use devices with contacts capable of switching micro loads of 24VDC, 5mA. Failure to open contacts of a contactor cannot be detected by monitoring its auxiliary NC contact without forcibly guided mechanism.
Other devices	Evaluate whether devices used are appropriate to satisfy the requirements of safety category level.

Precautions for Safe Use

- Use G9SX-SM□ within an enclosure with IP54 protection or higher of IEC/EN60529. Be sure to connect the enclosure to earth (PE).
- Incorrect wiring may lead to loss of safety function. Wire conductors correctly and verify the operation of G9SX-SM□ before commissioning the system in which G9SX-SM□ is incorporated.
- Do not apply DC voltages exceeding the rated voltages, or any AC voltages to the G9SX-SM□ power supply input.
- Use DC supply satisfying requirements below to prevent electric shock.
 - DC power supply with double or reinforced insulation, for example, according to IED/EN60950 or EN50178 or a transformer according to IEC/EN61558.
 - DC supply satisfies the requirement for class 2 circuits or limited voltage/current circuit stated in UL 508.
- Apply properly specified voltages to G9SX-SM□ inputs. Applying inappropriate voltages cause G9SX-SM□ to fail to perform its specified function, which leads to the loss of safety functions or damages to G9SX-SM□.
- Auxiliary error outputs and auxiliary monitoring outputs are NOT safety outputs. Do not use auxiliary outputs as any safety output. Such incorrect use causes loss of safety function of G9SX-SM□ and its relevant system.
- After installation of G9SX-SM□, qualified personnel should confirm the installation, and should conduct test operations and maintenance. The qualified personnel should be qualified and authorized to secure the safety on each phases of design, installation, running, maintenance and disposal of system.
- A person in charge, who is familiar to the machine in which G9SX-SM□ is to be installed, should conduct and verify the installation.
- G9SX-SM□ determines that motor stops when the standstill detection input voltage is predetermined value or less. According to the characteristic or load condition of motor, it may turn on safety detection outputs before motor stops completely. In that case, before operation, the qualified personnel should verify that risk of the rotation condition after output is acceptable.
- Perform daily and 6-month inspections for the G9SX-SM□. Otherwise, the system may fail to work properly, resulting in serious injury.
- Do not dismantle, repair, or modify G9SX-SM□. It may lead to loss of its safety functions.
- Use only appropriate components or devices complying with relevant safety standards corresponding to the required level of safety categories. Conformity to requirements of safety category is determined as an entire system. It is recommended to consult a certification body regarding assessment of conformity to the required safety level.
- OMRON shall not be responsible for conformity with any safety standards regarding to customer's entire system.
- Disconnect G9SX-SM□ from power supply when wiring, to prevent electric shock or unexpected operation.
- Be cautious not to have your fingers caught when attaching terminal sockets to the plugs on G9SX-SM□.
- Do not use in combustible gases or explosive gases.
- Driving voltage of the motor is impressed to the standstill detection inputs. Connect overcurrent protective equipment: fuse, circuit-breaker etc. (3A Max.) and tighten the wirings by rated tightening torque to the standstill detection inputs.

Precautions for Correct Use

1. Handle with care
Do not drop G9SX-SM□ to the ground or expose to excessive vibration or mechanical shocks. G9SX-SM□ may be damaged and may not function properly.
2. Conditions of storage
Do not store in such conditions stated below.
 - a. In direct sunlight
 - b. At ambient temperatures out of the range of -10 to 55°C.
 - c. At relative humidity out of the range of 25% to 85% or under such temperature change that causes condensation.
 - d. In corrosive or combustible gases
 - e. With vibration or mechanical shocks out of the rated values.
 - f. Under splashing of water, oil, chemicals
 - g. In the atmosphere containing dust, saline or metal powder. G9SX-SM□ may be damaged and may not function properly.
3. Mounting
Mount G9SX-SM□ to DIN rails with attachments (TYPE PFP-M, not incorporated to this product), not to drop out of rails by vibration etc. especially when the length of DIN railing is short compared to the widths of G9SX-SM□.
Do not use G9SX-SM□ at altitudes over 1,000 meters.
4. Following spacing around G9SX should be available to apply rated current to outputs of G9SX-SM□ and for enough ventilation and wiring:
 - a. At least 25 mm beside side faces of G9SX-SM□.
 - b. At least 50 mm above top face of G9SX-SM□ and below bottom face of G9SX-SM□.

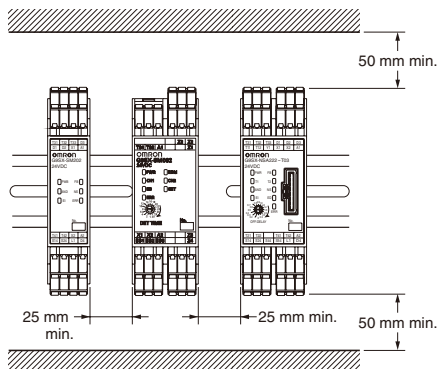

5. Wiring
 - a. G9SX-SM032-□
 - Use the following to wire to G9SX-SM□.

Solid wire	0.2 to 2.5mm ² AWG24 to AWG12
Stranded wire (Flexible wire)	0.2 to 2.5mm ² AWG24 to AWG12

- Strip the cover of wire no longer than 7mm.
- b. G9SX-SM□-RT (with screw terminals)
Tighten each screw with a specified torque of 0.5 to 0.6N·m, or the G9SX-SM□ may malfunction or generate heat.
6. Use cables with length less than 100m to connect to standstill detection Inputs and EDM input respectively.
 7. Driving voltage of the motor is impressed to the standstill detection input and there is a possibility that a high level of noise is superimposed. The line of the standstill input must be separately installed from other signal lines.
 8. Set the time duration of Standstill determining time to an appropriate value that does not cause the loss of safety function of system.
 9. Tuning Mode in User Configuration is only for adjusting the Standstill determining time. In Tuning Mode, auxiliary monitor output is enabled however Safety standstill detection outputs are not enabled. After the tuning is complete, be sure to change from Tuning Mode to Monitoring Mode for actual operation.
 10. Safety standstill detection outputs are only for controlling a guard lock safety-door switch with mechanical lock. They can not be used as safety outputs to drive contactors, or to control a guard lock safety-door switch with solenoid lock.
 11. To determine safety distance to hazards, take into account the delay of safety standstill detection outputs caused by the response time.
 12. Start entire system after more than 5s have passed since applying supply voltage to all G9SXs in the system.
 13. G9SX-SM□ may malfunction due to electro-magnetic disturbances. Be sure to connect the terminal A2 to ground.
 14. This is a class A product. In residential areas it may cause radio interference, in which case the user may be required to take adequate measures to reduce interference.
 15. Devices connected to G9SX-SM□ may operate unexpectedly. When replacing G9SX-SM□, disconnect it from power supply.
 16. Adhesion of solvent such as alcohol, thinner, trichloroethane or gasoline on the product should be avoided. Such solvents make the marking on G9SX-SM□ illegible and cause deterioration of parts.

17. Connectable motor

AC induction motors can be connected to the G9SX-SM□.

- Servo motors cannot be connected.
- When a motor with AC240V or more is used, connect neutral point of the power supply to earth.

18. G9SX-SM□ does not have motor fault detective function or motor protective function. For motor protection, use designated external protective devices.**19. For use with inverter**

The dynamic break setting time should be set to 30 seconds or shorter. Otherwise, the G9SX-SM□ may detect a disconnect fault of the wiring. Also in the following cases, the standstill detection function may not properly work even while the motor is in standstill.

- a. An inverter with a large output residual voltage is used, and the contactor connected in serial with the inverter is in the ON state.
- b. The inverter is executing the auto tuning function.

Safety Category (EN 954-1, ISO13849-1)

In the condition shown in Application Examples, G9SX can be used for the corresponding categories up to category 4 per EN954-1 and performance level (PL) up to PLe per ISO13849-1. This does NOT mean that G9SX-SM can always be used for required category under all the similar conditions and situations.

Conformity to the categories must be assessed as a whole system. When using G9SX-SM for safety categories, be sure to confirm the conformity as a whole system.

Safety Category 4 (EN 954-1, ISO13849-1)

- 1) Connect a fuse to each of the Standstill detection input lines.
- 2) Provide signals of different phases for the Standstill detection inputs (Z1-Z2, Z3-Z4).
- 3) Connect Guard lock Safety-door switches to any one of Safety Standstill detection outputs: ES1, ES2 or ES3.
- 4) Input the signal through a NC contact of the contactor to EDM input T31-T32. (Refer to "Application Examples" on page 9.)
- 5) Be sure to connect A2 to ground.

Compliance with International Standards

G9SX-SM032-□

- Certified by TÜV-SUD
 - EN954-1 Cat.4
 - IEC/EN61508 SIL3
 - IEC/EN62061 SIL3
 - ISO13849-1 PLe
 - EN1088
 - EN50178
 - IEC/EN60204-1
 - IEC/EN61000-6-2
 - IEC/EN61000-6-4
- Certified by UL
 - UL508
 - CAN/CSA C22.2 No.142

MEMO

READ AND UNDERSTAND THIS CATALOG

Please read and understand this catalog before purchasing the products. Please consult your OMRON representative if you have any questions or comments.

Warranty and Limitations of Liability

WARRANTY

OMRON's exclusive warranty is that the products are free from defects in materials and workmanship for a period of one year (or other period if specified) from date of sale by OMRON.

OMRON MAKES NO WARRANTY OR REPRESENTATION, EXPRESS OR IMPLIED, REGARDING NON-INFRINGEMENT, MERCHANTABILITY, OR FITNESS FOR PARTICULAR PURPOSE OF THE PRODUCTS. ANY BUYER OR USER ACKNOWLEDGES THAT THE BUYER OR USER ALONE HAS DETERMINED THAT THE PRODUCTS WILL SUITABLY MEET THE REQUIREMENTS OF THEIR INTENDED USE. OMRON DISCLAIMS ALL OTHER WARRANTIES, EXPRESS OR IMPLIED.

LIMITATIONS OF LIABILITY

OMRON SHALL NOT BE RESPONSIBLE FOR SPECIAL, INDIRECT, OR CONSEQUENTIAL DAMAGES, LOSS OF PROFITS OR COMMERCIAL LOSS IN ANY WAY CONNECTED WITH THE PRODUCTS, WHETHER SUCH CLAIM IS BASED ON CONTRACT, WARRANTY, NEGLIGENCE, OR STRICT LIABILITY.

In no event shall responsibility of OMRON for any act exceed the individual price of the product on which liability is asserted.

IN NO EVENT SHALL OMRON BE RESPONSIBLE FOR WARRANTY, REPAIR, OR OTHER CLAIMS REGARDING THE PRODUCTS UNLESS OMRON'S ANALYSIS CONFIRMS THAT THE PRODUCTS WERE PROPERLY HANDLED, STORED, INSTALLED, AND MAINTAINED AND NOT SUBJECT TO CONTAMINATION, ABUSE, MISUSE, OR INAPPROPRIATE MODIFICATION OR REPAIR.

Application Considerations

SUITABILITY FOR USE

OMRON shall not be responsible for conformity with any standards, codes, or regulations that apply to the combination of products in the customer's application or use of the product.

At the customer's request, OMRON will provide applicable third party certification documents identifying ratings and limitations of use that apply to the products. This information by itself is not sufficient for a complete determination of the suitability of the products in combination with the end product, machine, system, or other application or use.

The following are some examples of applications for which particular attention must be given. This is not intended to be an exhaustive list of all possible uses of the products, nor is it intended to imply that the uses listed may be suitable for the products:

- Outdoor use, uses involving potential chemical contamination or electrical interference, or conditions or uses not described in this document.
- Nuclear energy control systems, combustion systems, railroad systems, aviation systems, medical equipment, amusement machines, vehicles, safety equipment, and installations subject to separate industry or government regulations.
- Systems, machines, and equipment that could present a risk to life or property.

Please know and observe all prohibitions of use applicable to the products.

NEVER USE THE PRODUCTS FOR AN APPLICATION INVOLVING SERIOUS RISK TO LIFE OR PROPERTY WITHOUT ENSURING THAT THE SYSTEM AS A WHOLE HAS BEEN DESIGNED TO ADDRESS THE RISKS, AND THAT THE OMRON PRODUCT IS PROPERLY RATED AND INSTALLED FOR THE INTENDED USE WITHIN THE OVERALL EQUIPMENT OR SYSTEM.

Disclaimers

CHANGE IN SPECIFICATIONS

Product specifications and accessories may be changed at any time based on improvements and other reasons.

It is our practice to change model numbers when published ratings or features are changed, or when significant construction changes are made. However, some specifications of the product may be changed without any notice. When in doubt, special model numbers may be assigned to fix or establish key specifications for your application on your request. Please consult with your OMRON representative at any time to confirm actual specifications of purchased products.

DIMENSIONS AND WEIGHTS

Dimensions and weights are nominal and are not to be used for manufacturing purposes, even when tolerances are shown.

ERRORS AND OMISSIONS

The information in this document has been carefully checked and is believed to be accurate; however, no responsibility is assumed for clerical, typographical, or proofreading errors, or omissions.

PERFORMANCE DATA

Performance data given in this catalog is provided as a guide for the user in determining suitability and does not constitute a warranty. It may represent the result of OMRON's test conditions, and the users must correlate it to actual application requirements. Actual performance is subject to the OMRON Warranty and Limitations of Liability.

PROGRAMMABLE PRODUCTS

OMRON shall not be responsible for the user's programming of a programmable product, or any consequence thereof.

Copyright and Copy Permission

COPYRIGHT AND COPY PERMISSION

This document shall not be copied for sales or promotions without permission.

This document is protected by copyright and is intended solely for use in conjunction with the product. Please notify us before copying or reproducing this document in any manner, for any other purpose. If copying or transmitting this document to another, please copy or transmit it in its entirety.

OMRON Corporation
Industrial Automation Company

Safety Devices Division
Shiokoji Horikawa, Shimogyo-ku,
Kyoto, 600-8530 Japan
Tel: (81) 75-344-7093/Fax: (81) 75-344-8197

Regional Headquarters

OMRON EUROPE B.V.
Wegalaan 67-69-2132 JD Hoofddorp
The Netherlands
Tel: (31)2356-81-300/Fax: (31)2356-81-388

OMRON SCIENTIFIC TECHNOLOGIES INC.

6550 Dumbarton Circle, Fremont
CA 94555-3605 U.S.A.
Tel: (1) 510-608-3400/Fax: (1) 510-744-1442

OMRON ASIA PACIFIC PTE. LTD.

No. 438A Alexandra Road # 05-05/08 (Lobby 2),
Alexandra Technopark, Singapore 119967
Tel: (65) 6835-3011/Fax: (65) 6835-2711

OMRON (CHINA) CO., LTD.

Room 2211, Bank of China Tower,
200 Yin Cheng Zhong Road,
PuDong New Area, Shanghai, 200120, China
Tel: (86) 21-5037-2222/Fax: (86) 21-5037-2200

Authorized Distributor:

© OMRON Corporation 2008 All Rights Reserved.
In the interest of product improvement,
specifications are subject to change without notice.

CSM_4_1_0409
Cat. No. J171-E1-01

Printed in Japan
0608