



Features

- High Linearity: OIP3=43dBm at 880MHz
- Low Noise: NF<4dB
- Low DC Power: 5V, 90mA
- 400MHz to 2700MHz Operation
- Thermally Enhanced Slug Package

Applications

- GaAs Pre-Driver for Base Station Amplifiers
- PA Stage for Commercial Wireless Infrastructure
- Class AB Operation for DCS, PCS, UMTS, and WLAN Transceiver Applications
- 2nd/3rd Stage LNA for Wireless Infrastructure

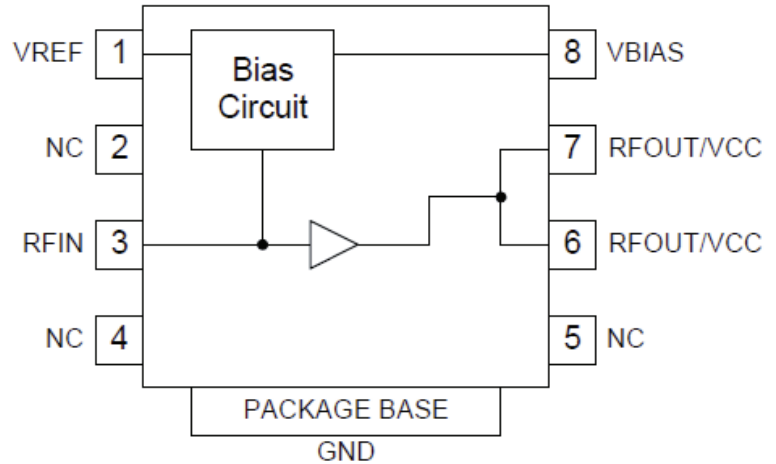

Functional Block Diagram

Product Description

The RFPA3807 is a GaAs HBT linear power amplifier specifically designed for Wireless Infrastructure applications. Using a highly reliable GaAs HBT fabrication process, this high performance single-stage amplifier achieves ultra-high linearity over a broad frequency range. It also offers low noise figure making it an excellent solution for 2nd and 3rd stage LNAs. The RFPA3807 also exhibits excellent thermal performance through the use of a thermally-enhanced plastic surface-mount slug package.

Ordering Information

RFPA3807SQ	Sample Bag with 25 pieces
RFPA3807SR	7" Reel with 100 pieces
RFPA3807TR7	7" Reel with 750 pieces
RFPA3807TR13	13" Reel with 2500 pieces
RFPA3807PCK-410	869MHz to 960MHz PCBA with 5-piece Sample Bag
RFPA3807PCK-411	2110MHz to 2170MHz PCBA with 5-piece Sample Bag

Optimum Technology Matching® Applied

- | | | | |
|--|--------------------------------------|-------------------------------------|------------------------------------|
| <input checked="" type="checkbox"/> GaAs HBT | <input type="checkbox"/> SiGe BiCMOS | <input type="checkbox"/> GaAs pHEMT | <input type="checkbox"/> GaN HEMT |
| <input type="checkbox"/> GaAs MESFET | <input type="checkbox"/> Si BiCMOS | <input type="checkbox"/> Si CMOS | <input type="checkbox"/> BiFET HBT |
| <input type="checkbox"/> InGaP HBT | <input type="checkbox"/> SiGe HBT | <input type="checkbox"/> Si BJT | <input type="checkbox"/> LDMOS |

RF MICRO DEVICES®, RFMD®, Optimum Technology Matching®, Enabling Wireless Connectivity™, PowerStar®, POLARIS™ TOTAL RADIO™ and UltimateBlue™ are trademarks of RFMD, LLC. BLUETOOTH is a trademark owned by Bluetooth SIG, Inc., U.S.A. and licensed for use by RFMD. All other trade names, trademarks and registered trademarks are the property of their respective owners. ©2006, RF Micro Devices, Inc.

Absolute Maximum Ratings

Parameter	Rating	Unit
Supply Voltage (V_{CC} and V_{BIAS})	6.5	V
Reference Current (I_{REF})	5	mA
DC Supply Current (I_C)	256	mA
CW Input Power, 2:1 Output VSWR	23	dBm
Output Load VSWR at P3dB	5:1	
Operating Junction Temperature	160	°C
Operating Temperature Range (T_L)	-40 to +85	°C
Storage Temperature	-55 to +150	°C
ESD Rating: Human Body Model	Class 1B	
Moisture Sensitivity Level	MSL 2	



Caution! ESD sensitive device.

Exceeding any one or a combination of the Absolute Maximum Rating conditions may cause permanent damage to the device. Extended application of Absolute Maximum Rating conditions to the device may reduce device reliability. Specified typical performance or functional operation of the device under Absolute Maximum Rating conditions is not implied.

RoHS status based on EUDirective2002/95/EC (at time of this document revision).

The information in this publication is believed to be accurate and reliable. However, no responsibility is assumed by RF Micro Devices, Inc. ("RFMD") for its use, nor for any infringement of patents, or other rights of third parties, resulting from its use. No license is granted by implication or otherwise under any patent or patent rights of RFMD. RFMD reserves the right to change component circuitry, recommended application circuitry and specifications at any time without prior notice.

- Notes:
1. The maximum ratings must all be met simultaneously.
 2. $P_{diss} = P_{DC} + P_{RFIN} - P_{RFOUT}$
 3. $T_J = T_L + P_{diss} * R_{th}$

Parameter	Specification			Unit	Condition
	Min.	Typ.	Max.		
860MHz to 960MHz					$V_{CC}=5.0V, V_{BIAS}=5.0V, I_{CQ}=90mA$
Frequency	860		960	MHz	Tuned for 880MHz useful to 960MHz
Input Power (P_{IN})			15	dBm	$V_{CC} < 6.0V$, max recommended
Gain (S21)		15.8		dB	
OIP3		43		dBm	12 dBm/tone, tone spacing= 1 MHz
P1dB		25		dBm	
Efficiency at P3dB		58		%	At P3dB
Input Return Loss (S11)		18		dB	869MHz to 894 MHz band
Output Return Loss (S22)		11		dB	
Noise Figure		3.5		dB	869MHz to 894 MHz band
WCDMA Ch Power at -65dBc ACPR		12.9		dBm	3GPP 3.5, Test Model 1, 64 DPCH
WCDMA Ch Power at -55dBc ACPR		14.6		dBm	3GPP 3.5, Test Model 1, 64 DPCH
UMTS2100					$V_{CC}=5.0V, V_{BIAS}=5.0V, I_{CQ}=90mA$
Frequency	2110	2140	2170	MHz	
Input Power (P_{IN})			15	dBm	$V_{CC} < 6.0V$, max recommended
Gain (S21)		13.7		dB	
OIP3		42		dBm	12 dBm/tone, tone spacing= 1 MHz
P1dB		24		dBm	
Efficiency at P3dB		56		%	At P3dB
Input Return Loss (S11)		15		dB	
Output Return Loss (S22)		13.5		dB	
Noise Figure		2.9		dB	
WCDMA Ch Power at -65dBc ACPR		11.5		dBm	3GPP 3.5, Test Model 1, 64 DPCH
WCDMA Ch Power at -55dBc ACPR		13.2		dBm	3GPP 3.5, Test Model 1, 64 DPCH
Power Supply					
Operating Current (Quiescent)	80	90	115	mA	At $V_{CC}=5.0V$
Operating Voltage (V_{CC})		5.0	6.0	V	Max recommended collector voltage
Thermal Resistance (R_{TH})		95		C/W	At quiescent current, no RF
Power Down Current			20	µA	At $V_{REF}=0V$

Typical Performance
(869MHz to 960MHz Application Circuit)

S11 versus Frequency

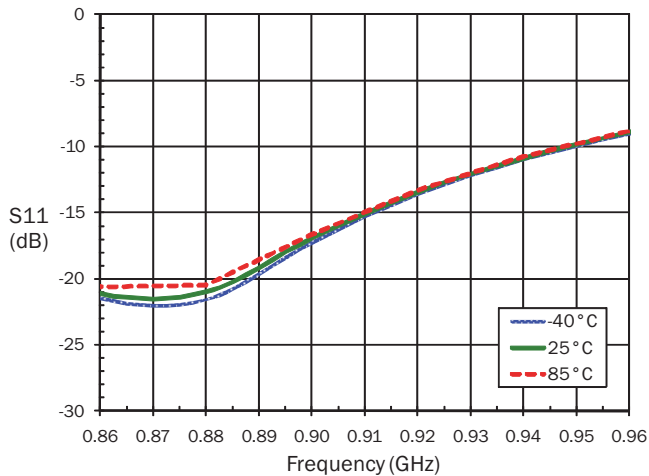

S21 versus Frequency

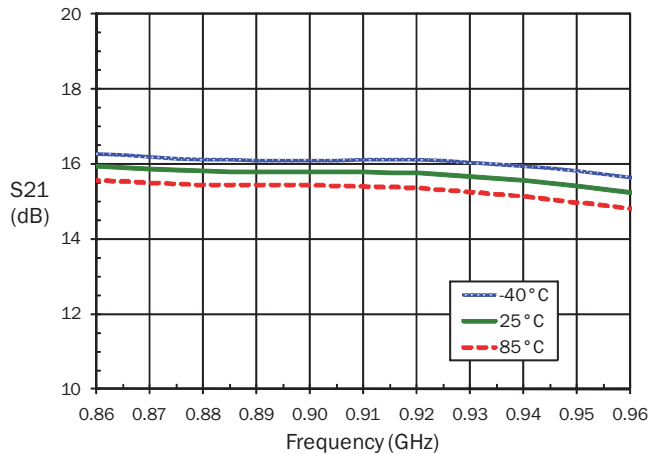

S12 versus Frequency

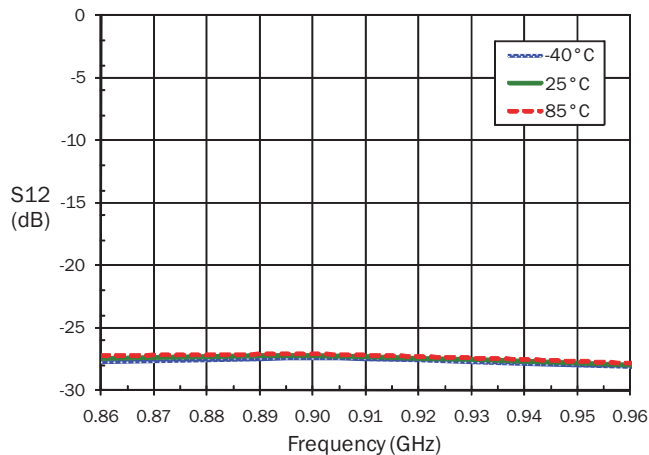

S22 versus Frequency

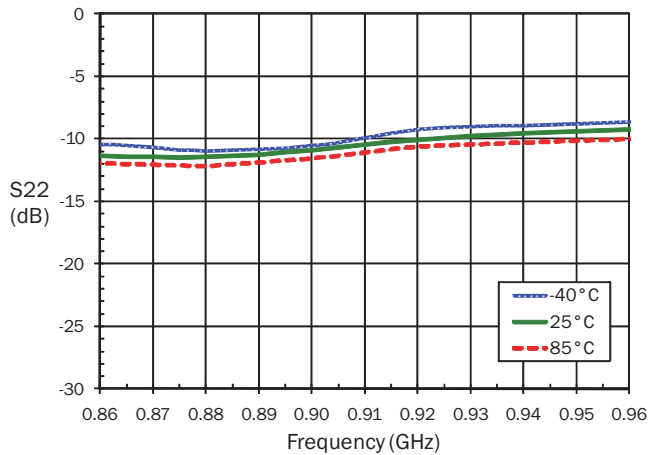

Noise Figure versus Frequency

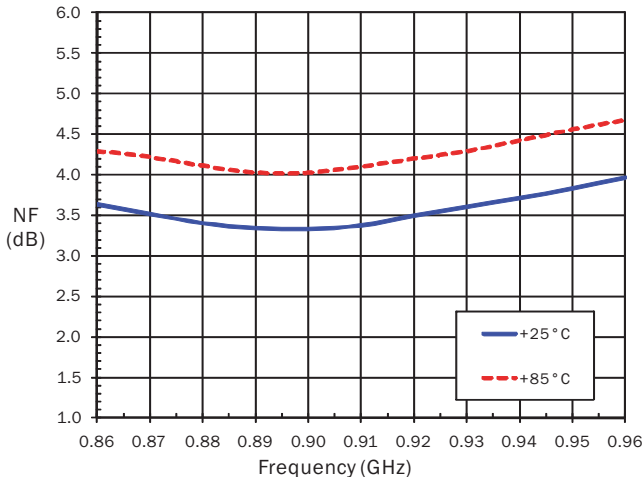

P1dB versus Frequency

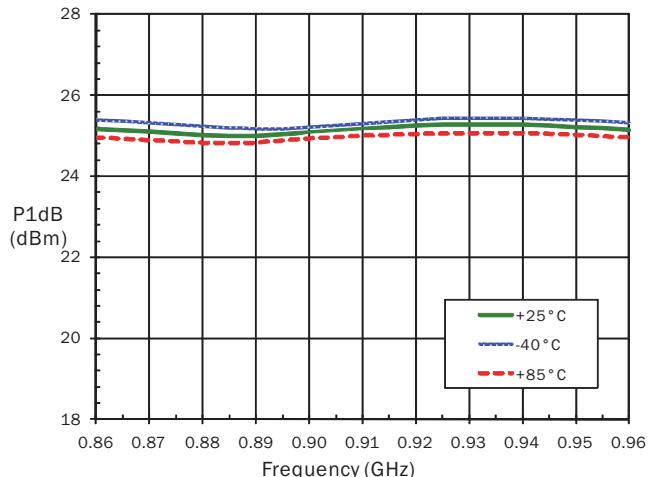

Typical Performance (869MHz to 960MHz Application Circuit)

OIP3 vs Freq. (12dBm tones, 1 MHz spacing)

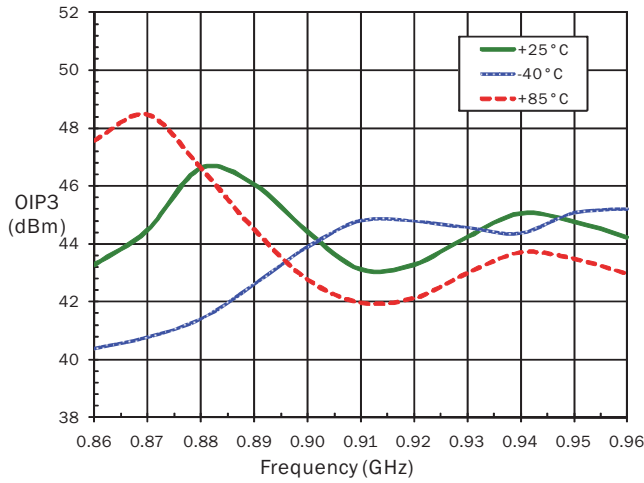

P_{OUT} versus P_{IN} at 880MHz

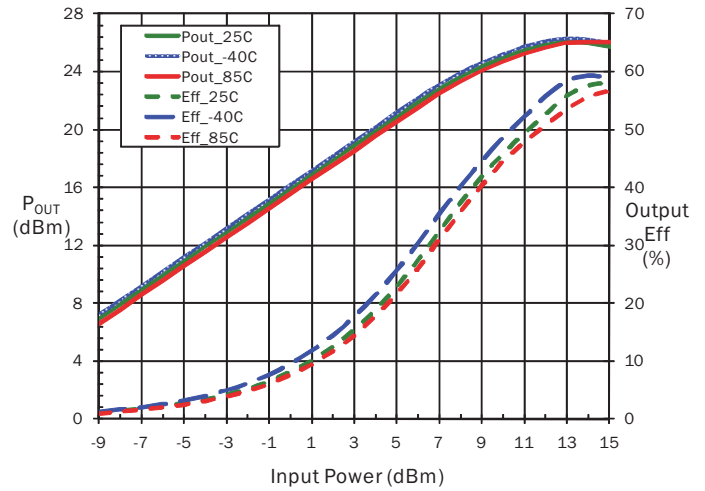

OIP3 versus Tone Power (880MHz, 1MHz Spacing)

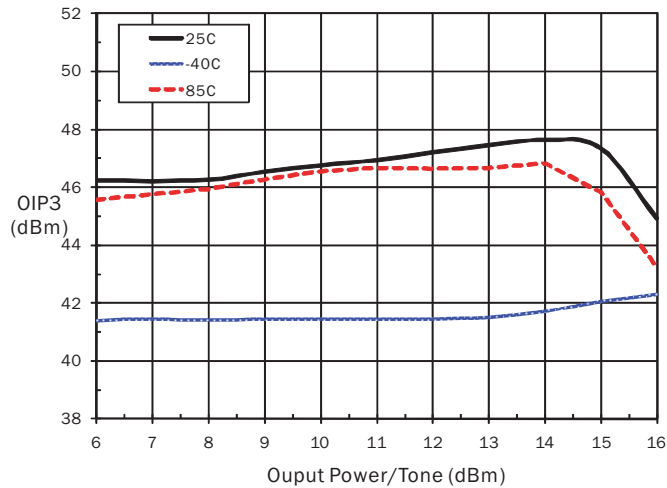

OIP3 versus Tone Power (940MHz, 1MHz Spacing)

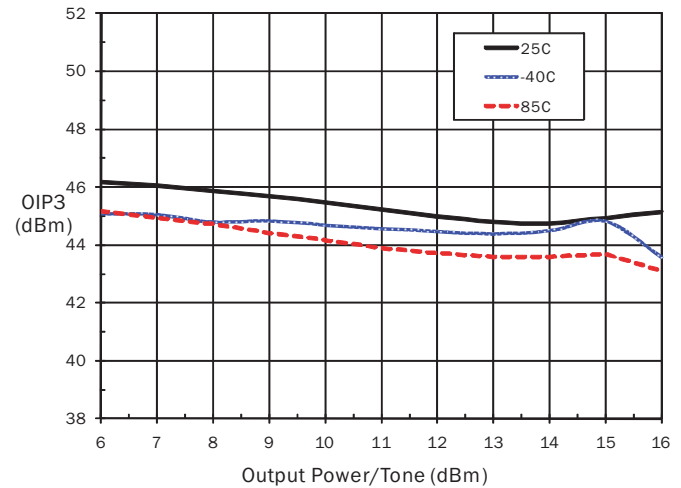

ACPR versus WCDMA Channel Power (880MHz)

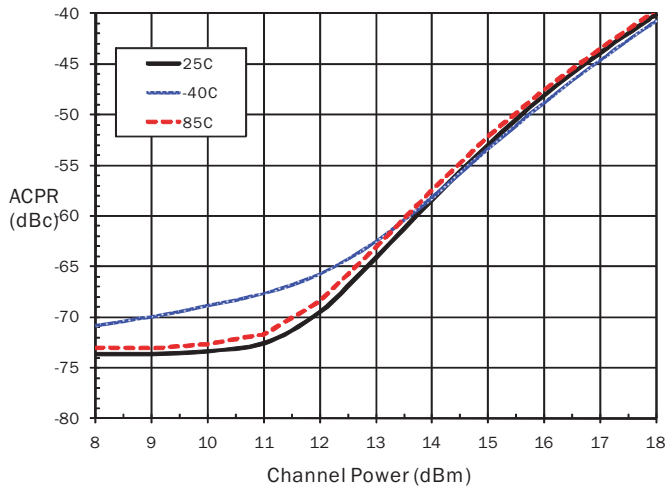

ACPR versus WCDMA Channel Power (25 °C)

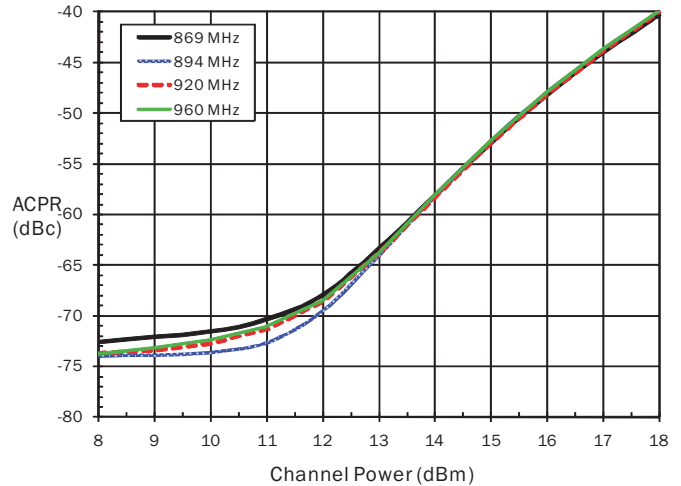

Evaluation Board Schematic
(869MHz to 960MHz Application Circuit)

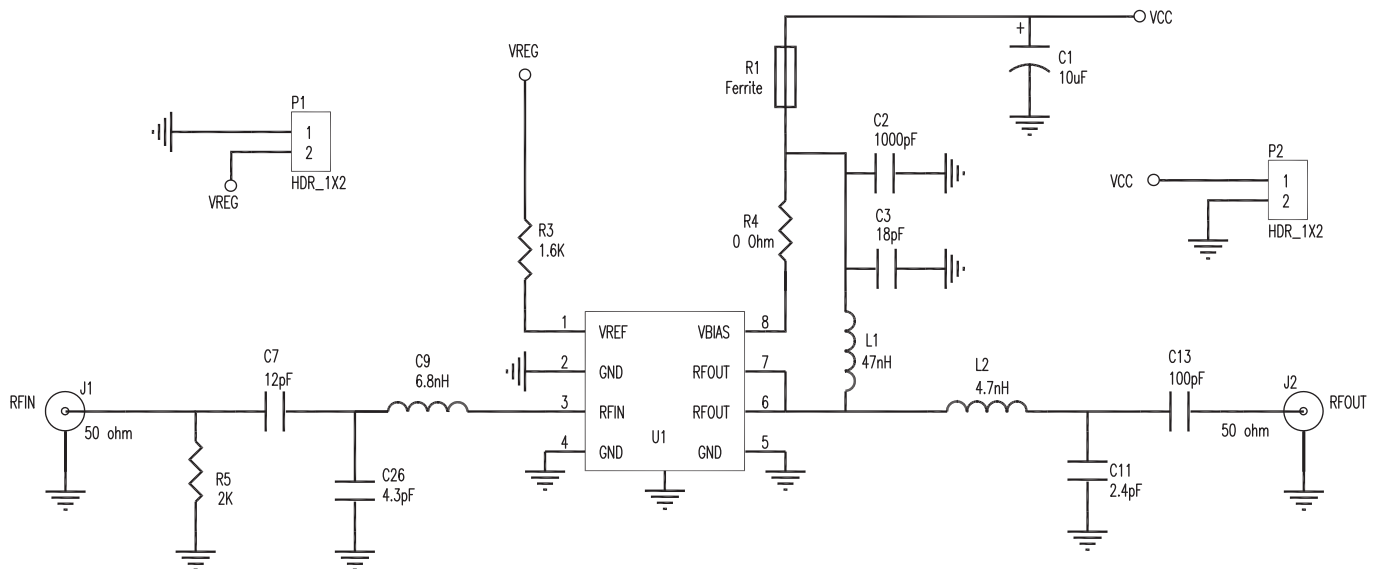

EVB BOM

(869MHz to 960MHz Application Circuit)

Description	Reference Designator	Manufacturer	Manufacturer's P/N
PCB, PA380X410		DDI	PA380X410(A)
RFPA3807SB	U1	RFMD	RFPA3807SB
CAP, 10µF, 10%, 10V, TANT-A	C1	AVX Corporation	TAJA106K010R
CAP, 1000pF, 10%, 50V, X7R, 0402	C2	Taiyo Yuden	RM UMK105BJ102KV-F
CAP, 18pF, 5%, 50V, COG, 0402	C3	Taiyo Yuden	RM UMK105 CG180JV-F
CAP, 12pF, 5%, 50V, COG, 0402	C7	Murata	GRM1555C1H120JZ01E
CAP, 4.3pF, ±0.25pF, 50V, COG, 0402	C26	Taiyo Yuden	RM UMK105CG4R3C
IND, 6.8nH, 5%, M/L, 0402	C9	Toko	LL1005-FHL6N8J
CAP, 2.4pF, ±0.25pF, 50V, COG, 0402	C11	Taiyo Yuden	RM UMK105CG2R4CW
CAP, 100pF, 5%, 50V, COG, 0402	C13	Murata	GRM1555C1H101JZ01D
IND, 47nH, 5%, W/W, 0603	L1	Coilcraft	0603HC-47NXJLW
IND, 4.7nH, ±0.3nH, M/L, 0402	L2	Toko	LL1005-FH4N7S
CONN, SMA, END, LNCH, FLT, 0.068"	J1, J2	Emerson	142-0701-851
CONN, HDR, ST, 2-PIN, 0.100"	P1, P2	Sullins Electronics	PBC02SAAN
FERRITE BEAD, 260Ω, 2A, 0603	R1	Murata	BLM18EG221SN1D
RES, 1.6K, 5%, 1/16W, 0402	R3	Kamaya, Inc	RMC1/16S-162JTH
RES, 0Ω, 0603	R4	Kamaya, Inc	RMC1/16JPTP
RES, 2K, 5%, 1/16W, 0402	R5	Kamaya, Inc	RMC1/16S-202JTH
Do Not Place (DNP)	C4-C6, C8 C10, C12, C14-C25, C27-C29, R2, R6-R8		

Typical Performance (2110MHz to 2170MHz Application Circuit)

S11 versus Frequency

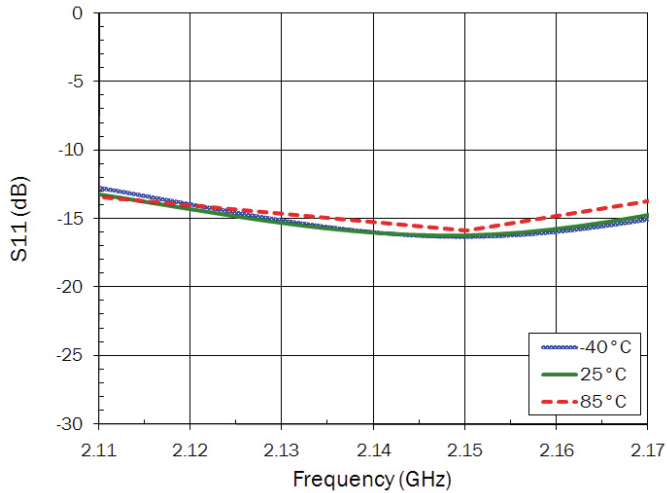

S21 versus Frequency

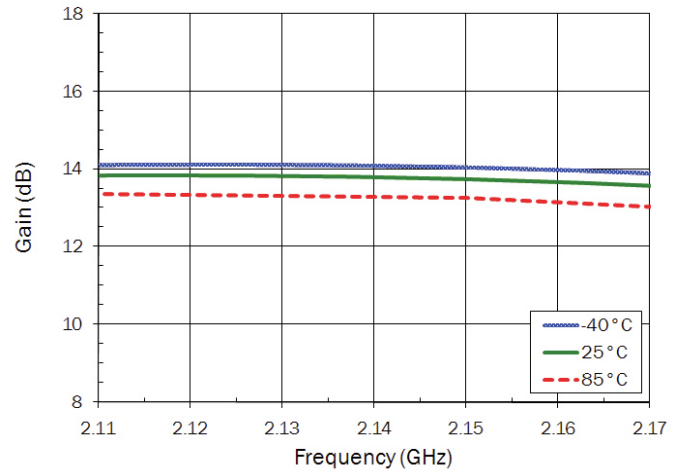

S12 versus Frequency

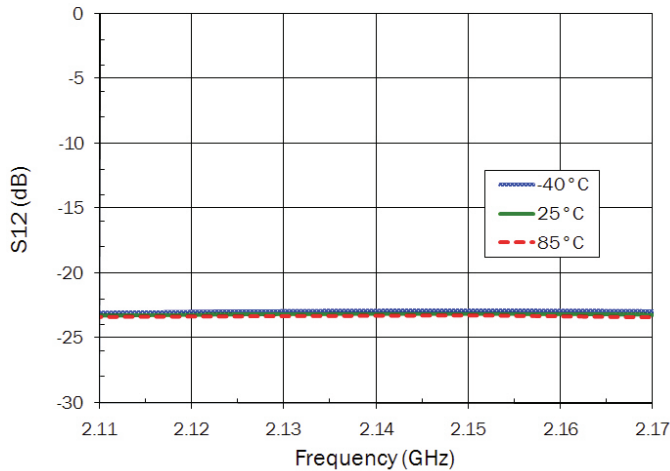

S22 versus Frequency

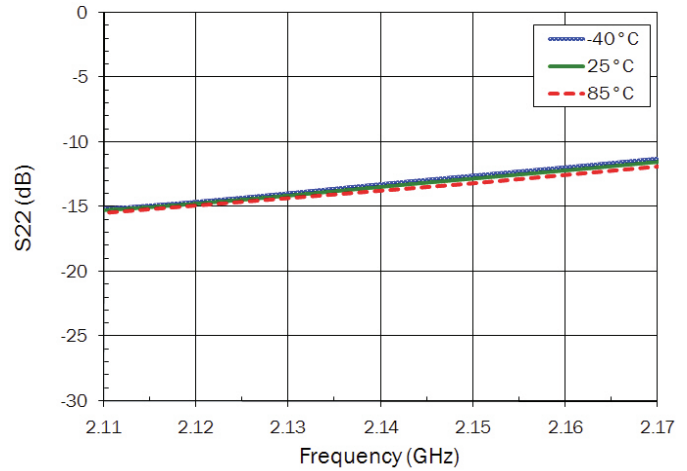

Noise Figure versus Frequency

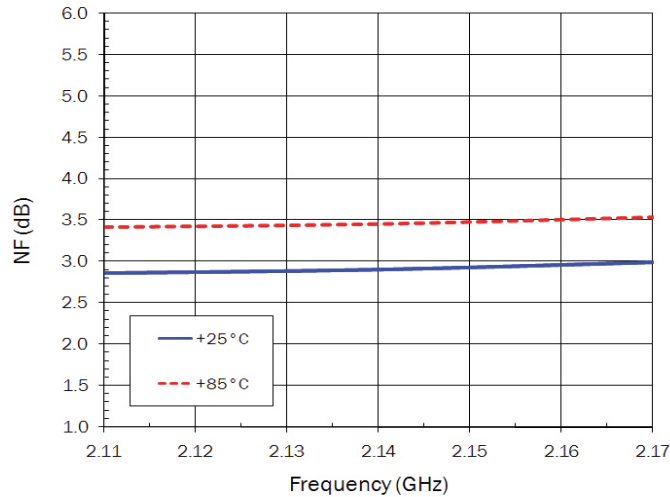

P1dB versus Frequency

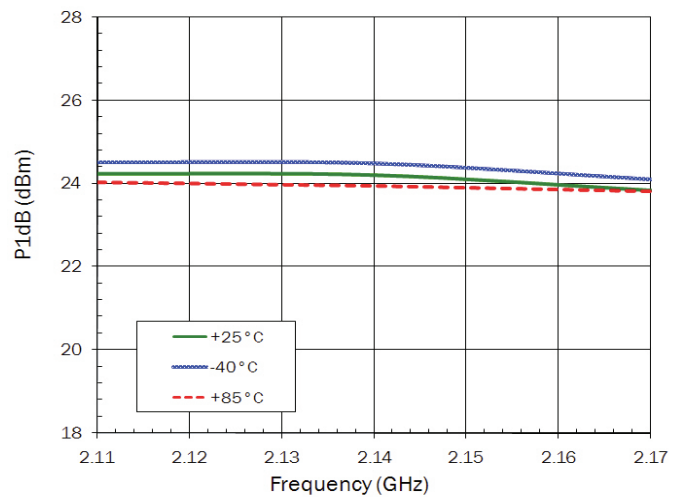

Typical Performance
(2110MHz to 2170MHz Application Circuit)

OIP3 vs Freq. (12dBm tones, 1 MHz spacing)

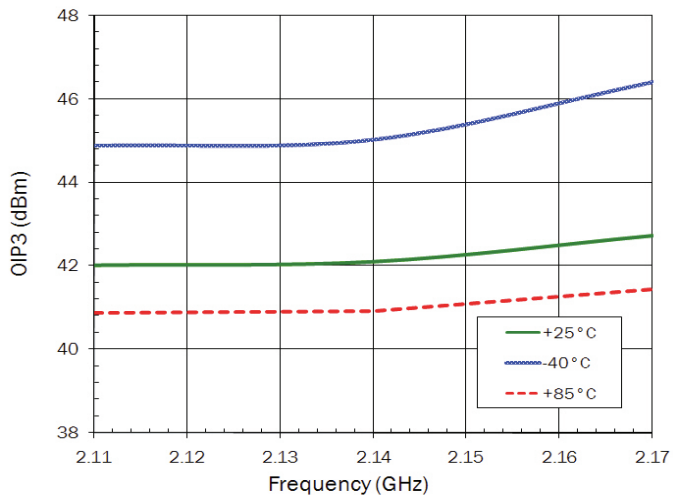

Pout versus Pin @2140MHz

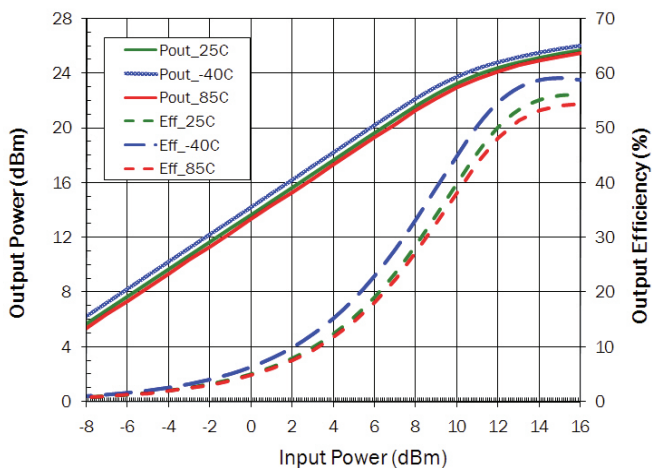

OIP3 vs Tone Power (2140MHz, 1 MHz spacing)

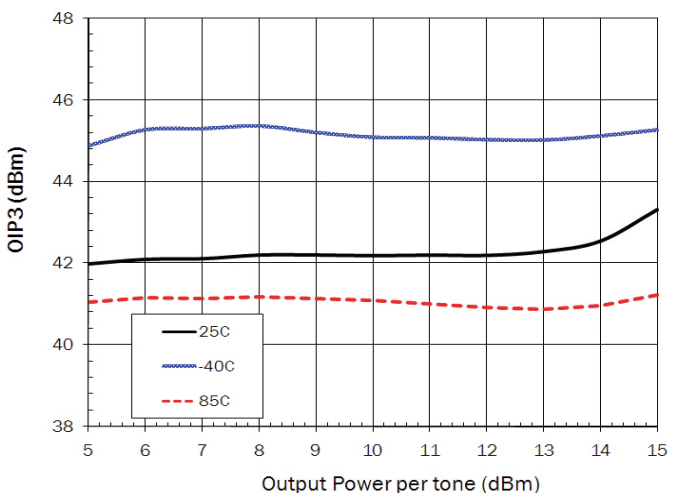

OIP3 vs Tone Power (1 MHz Spacing, 25 °C)

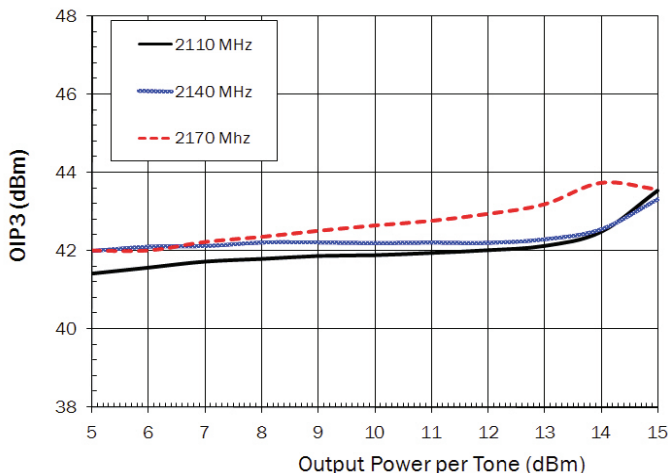

ACP versus WCDMA Channel Power (2140MHz)

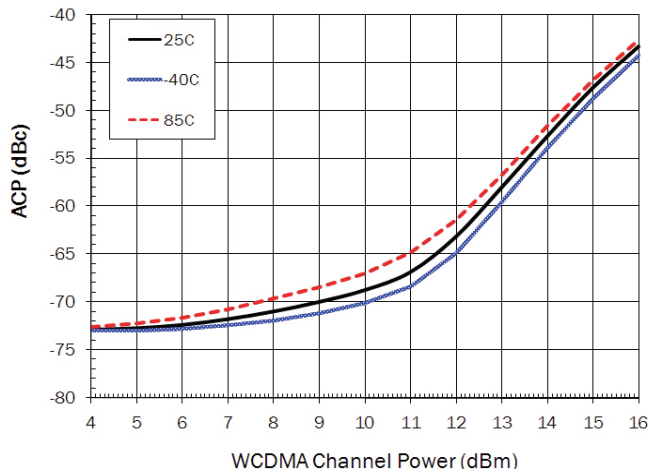

ACP versus Channel Power (25 °C)

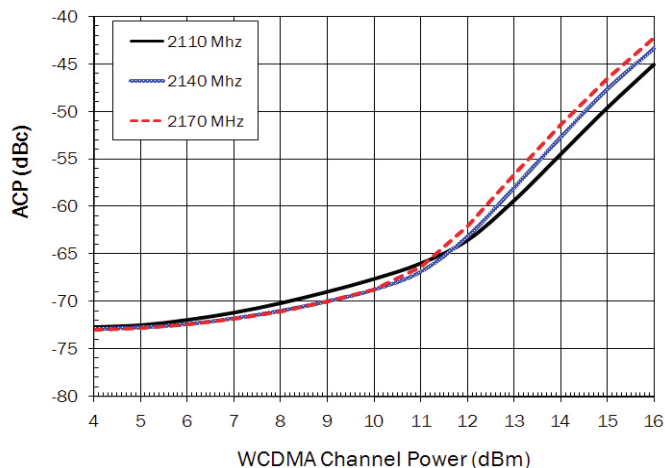

Evaluation Board Schematic (2110MHz to 2170MHz Application Circuit)

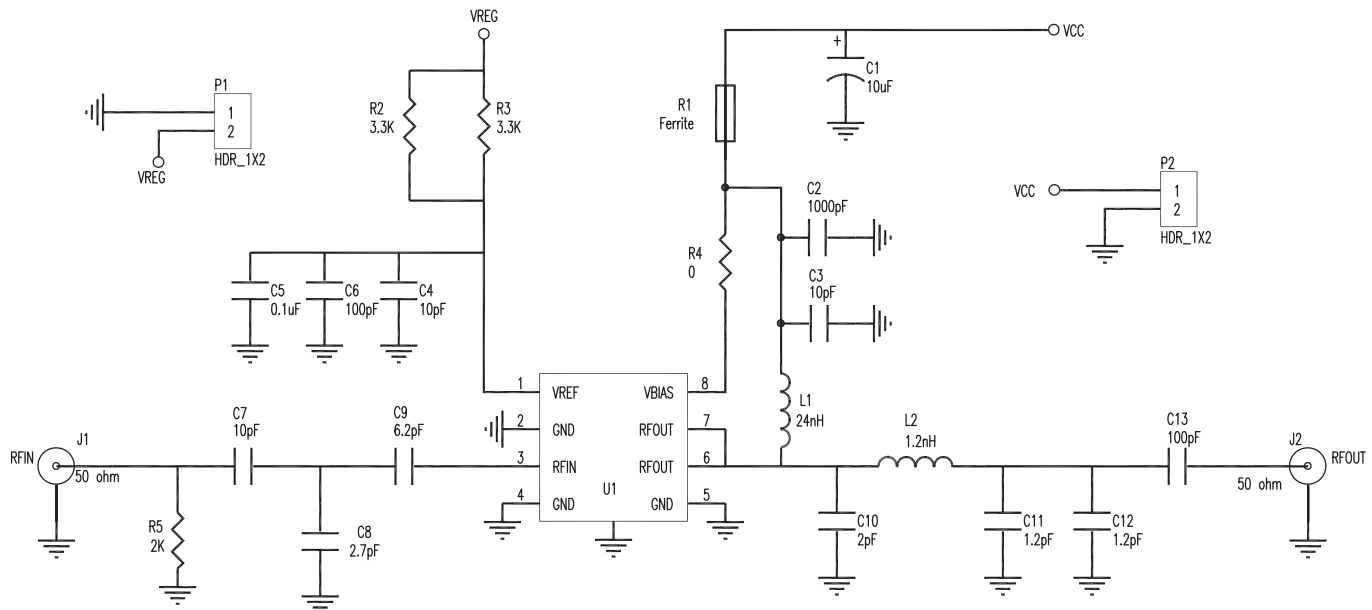

EVB BOM

(2110MHz to 2170MHz Application Circuit)

Description	Reference Designator	Manufacturer	Manufacturer's P/N
PCB, PA380X410			PA380X410(A)
CAP, 10μF, 10%, 10V, TANT-A	C1	AVX Corporation	TAJA106K010R
CAP, 1000pF, 10%, 50V, X7R, 0402	C2	Taiyo Yuden (USA), Inc.	RM UMK105BJ102KV-F
CAP, 10pF, 5%, 50V, COG, 0402	C3, C4, C7	Murata Electronics	GRM1555C1H100JZ01E
CAP, 0.1uF, 10%, 16V, X7R, 0402	C5	Murata Electronics	GRM155R71C104KA88D
CAP, 100pF, 5%, 50V, COG, 0402	C6	Taiyo Yuden (USA), Inc.	RM UMK105CG101JV-F
CAP, 2.7 pF, ±0.1pF, 50V, COG, 0402	C8	Murata Electronics	GRM1555C1H2R7BZ01E
CAP, 6.2pF, ±0.1pF, 50V, COG, 0402	C9	Murata Electronics	GRM1555C1H6R2BZ01E
CAP, 2 pF, ±0.1pF, 50V, HI-Q, 0402	C10	Johanson Technology	500R07S2R0BV4TD
CAP, 1.2pF, ±0.1pF, 50V, HI-Q, 0402	C11, C12	Johanson Technology	500R07S1R2BV4TD
CAP, 100pF, 5%, 50V, COG, 0402	C13	Murata Electronics	GRM1555C1H101JZ01D
IND, 24 nH, 5%, W/W, 0603	L1	Coilcraft	0603HC-24NXJLW
IND, 1.2 nH, ±0.3nH, M/L, 0402	L2	Toko America, Inc.	LL1005-FH1N2S
CONN, SMA, END, LAUNCH, RND, PIN, 0.062"	J1, J2	GIGALANE CO., LTD.	PAF-S05-008
CONN, HDR, ST, 2-PIN, 0.100	P1, P2	Sullins Electronics	PBC02SAAN
RFPA3807SB	U1	RFMD	RFPA3807SB
FER, BEAD, 260Ω, 2A, 0603	R1	Murata Electronics	BLM18EG221SN1D
RES, 3.3K, 5%, 1/16W, 0402	R2, R3	Kamaya, Inc	RMC1/16S-332JTH
RES, 0Ω, 0603	R4	Kamaya, Inc	RMC1/16JPTP
RES, 2K, 5%, 1/16W, 0402	R5	Kamaya, Inc	RMC1/16S-202JTH
Do Not Place	C14, C15, C16, C17, C18, C19, C20, C21, C22, C23, C24, C25, C26, C27, C28, C29, R6, R7, R8		

Evaluation Board Assembly Drawing

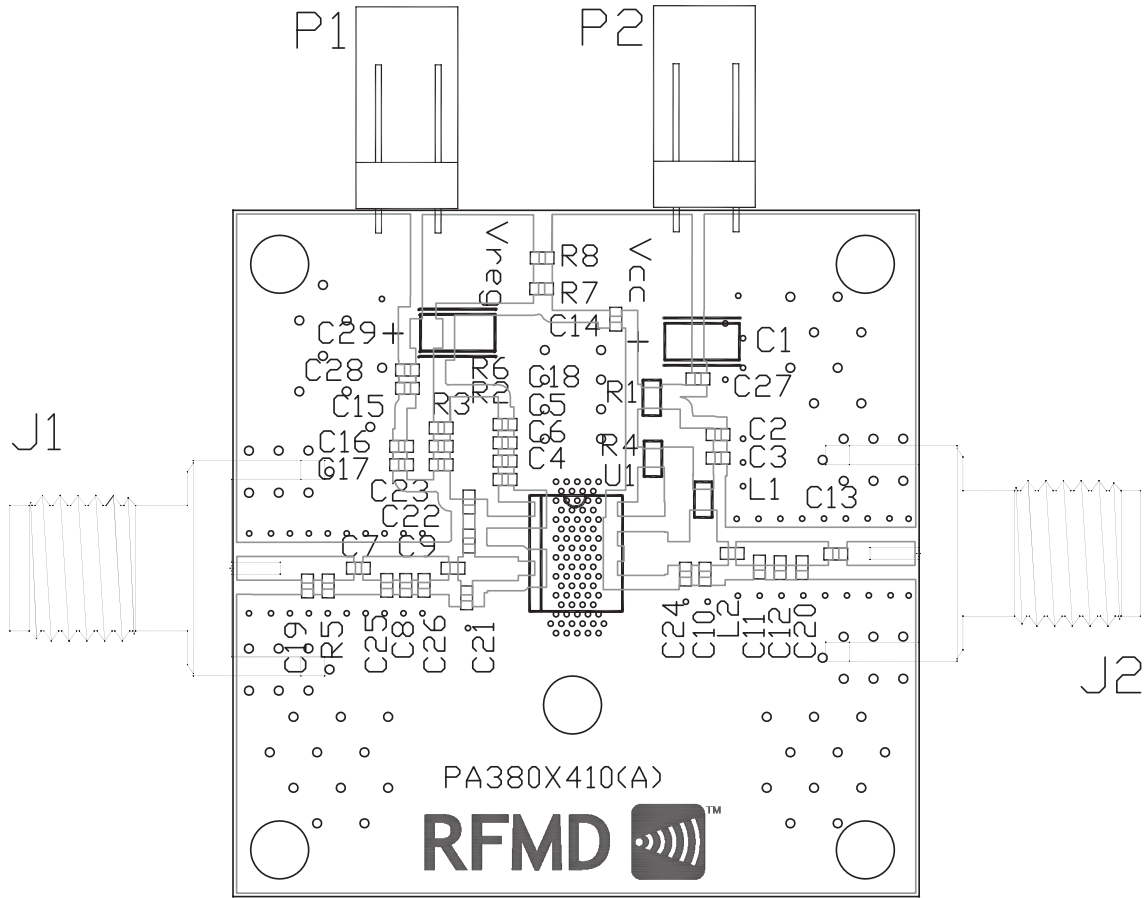

Pin	Function	Description
1	VREF	Control input to the active bias circuit to set I_{CQ} . Can be used as a power-down pin.
2	NC	No connection.
3	RF IN	RF input. External DC block is required.
4	NC	No connection.
5	NC	No connection.
6	RF OUT/VCC	RF output, device collector.
7	RF OUT/VCC	RF output, device collector.
8	VBIAS	Supply voltage for the active bias circuit.
EPAD	GND	DC and RF ground. Must be soldered to EVB ground plane over a bed of vias for thermal and RF performance.

Package Drawing

Dimensions in inches (millimeters)

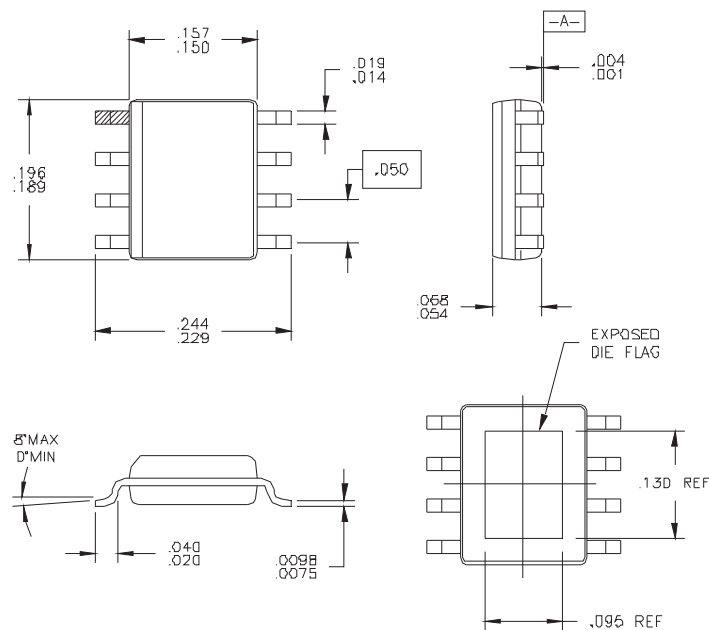

Branding Diagram

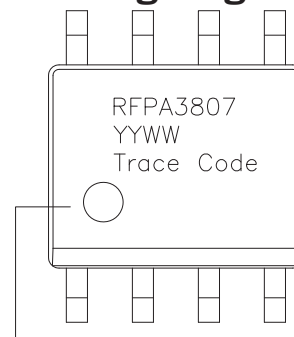

Pin 1 Indicator

YYWW=date code where YY=year, WW=week. Trace Code=lot code assigned by packaging supplier.