



PC, DVI, VIDEO INTERFACE CONTROLLER FOR TFT PANEL

Model: SVH-1920+

Part number : 41717002X-3 or up

INSTRUCTIONS

CONTENTS

- Page: **2. Introduction, How to Proceed, Usage Note, Disclaimer**
3. System design – Diagram of a suggested system
4. Assembly notes – Important information about system elements
6. Connection & Operation – How to use the controller
11. Connectors, pinouts & jumpers – Essential connection information
23. Controller dimensions
25. Application notes
27. Troubleshooting
28. Specifications
29. Appendix I – Supported graphics modes table
32. Appendix II – RS-232 control protocols
44. Appendix III – Mapping definition
46. Appendix IV – Auto Color Gain
47. Appendix V – DV remote control unit work for SVH-1920+
48. Appendix VI – Function description for de-interlacing mode AFM, TNR, MADI, DCDi
48. Appendix VII – PIP mix table
49. Appendix IX – Specification for inverter Interface Board P/N 416040010-3
52. Appendix X - Specification for audio add-on board P/N 416940020-3
54. Warranty, Caution & Limitation of Liability, Trademarks
55. Contact details

It is essential that these instructions are read and understood before connecting or powering up this controller.

Introduction

Designed for LCD monitor and other flat panel display applications, the SVH-1920+ is a feature rich interface controller for :

- TFT (active matrix) LCD panels of 1920x1200, 1920x1080, 1920x480, 1600x1200, 1680x1050, 1440x900, 1366x768, 1280x1024, 1280x800, 1280x768 1024x768, 1024x600, 800x600, 800x480 and 640x480 resolutions.
- Computer video signals of VGA, SVGA, XGA, SXGA, WXGA, UXGA, WUXGA standard.
- Video signals of NTSC, PAL and SECAM standard.
- DVI input support up to 1920x1200 60Hz input signals
- Support up to 8 bits panel
- Support DVI, VGA, S-Video, Composite, Component Video input

HOW TO PROCEED

- Ensure you have all parts & that they are correct, refer to:
 - Connection diagram

Controller Solution Generator

Full web resource matching controllers & panels with **connection diagrams** for download.
See at : <http://www.digitalview.com/controllers/csg.php>

- Connector reference (in following section)
- Assembly notes
- Check controller switch & jumper settings (errors may damage the panel)
- Prepare the PC
- Connect the parts
- Understand the operation & functions

IMPORTANT USAGE NOTE

This equipment is for use by developers and integrators, the manufacturer accepts no liability for damage or injury caused by the use of this product. It is the responsibility of the developer, integrators or other user of this product to:

- Ensure that all necessary and appropriate safety measures are taken.
- Obtain suitable regulatory approvals as may be required.
- **Check power settings to all component parts before connection.**

DISCLAIMER

There is no implied or expressed warranty regarding this material.

SYSTEM DESIGN

A typical LCD based display system utilizing this controller is likely to comprise the following:

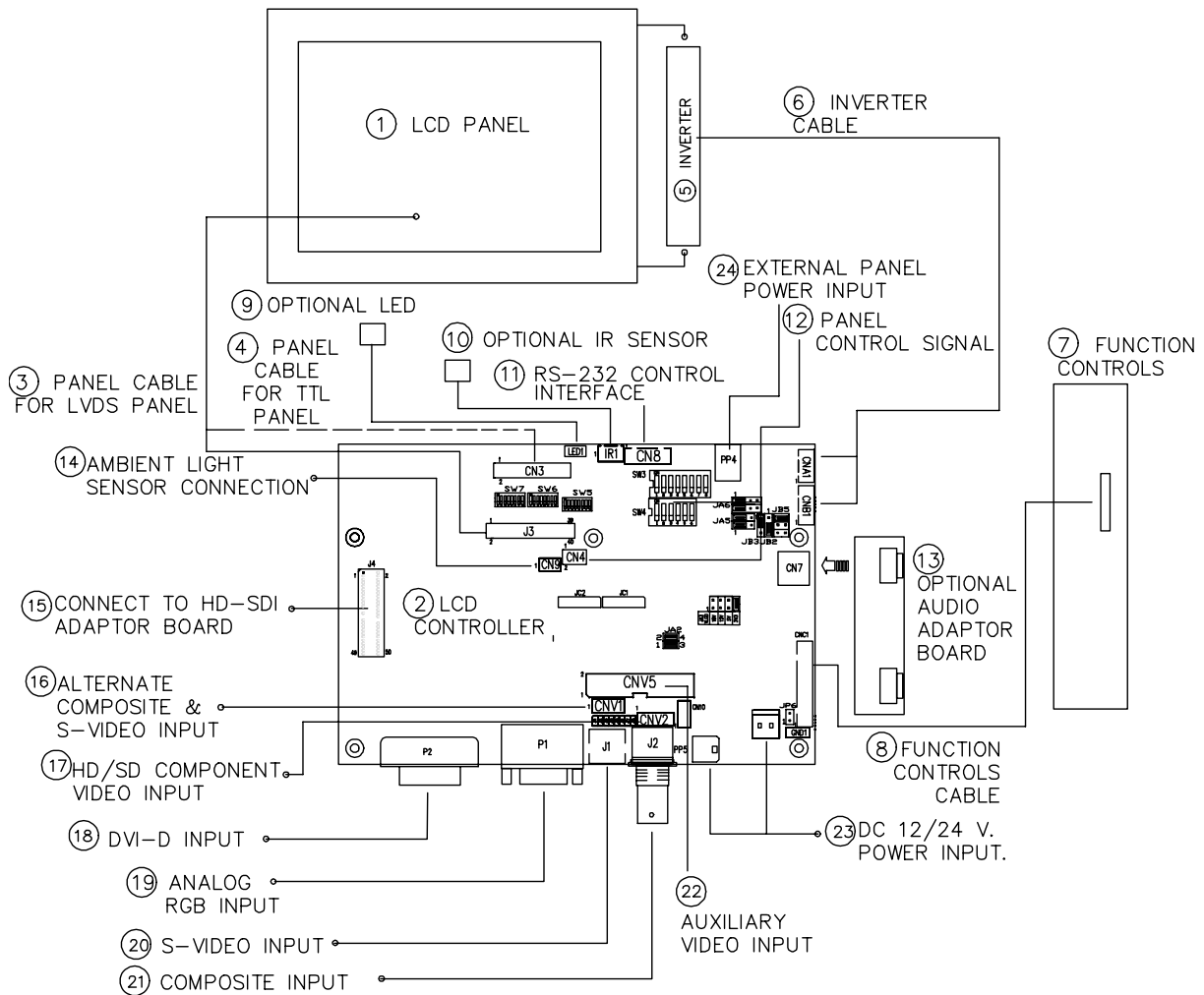

Summary:

1. LCD panel
2. LCD controller card, SVH-1920+
3. LCD signal cable (use for LVDS panel)
4. LCD signal cable (use for TTL single pixel panel)
5. Inverter for backlight (if not built into LCD)
6. Inverter cable
7. Function controls
8. Function controls cable
9. Status LED (optional)
10. IR sensor (optional)
11. RS-232 control interface
12. Panel control signal
13. Audio add-on board (optional)
14. Ambient light sensor connection
15. Connect to HD-SDI adaptor board (HD-1000/HD-2000)
16. Alternate Composite & S-video input
17. HD/SD Component video input
18. DVI-D input
19. Analog RGB input
20. S-Video input
21. Composite input
22. Auxiliary video input
23. +12V / +24V DC power input
24. External panel power input

Digital View provides a range of parts, such as listed above, to make up complete display solutions.

ASSEMBLY NOTES

This controller is designed for monitor and custom display projects using 1920x1200 or 1920x1080 or 1920x480 or 1600x1200 or 1680x1050 or 1440x900 or 1366x768 or 1280 x 1024 or 1024 x 768 or 1024x600 or 800x600 or 640x480 resolution TFT panels with a VGA, SVGA, WXGA, XGA, SXGA, UXGA or WUXGA signal input. The following provides some guidelines for installation and preparation of a finished display solution.

Preparation: Before proceeding it is important to familiarize yourself with the parts making up the system and the various connectors, mounting holes and general layout of the controller. As much as possible connectors have been labeled. Guides to connectors and mounting holes are shown in the following relevant sections.

- LCD Panel:** This controller is designed for typical LVDS or TTL interfaced panels with panel voltage 3.3V, 5V or 12V, External for 12V~18V interface. Due to the variation between manufacturers of panels signal timing and other panel characteristics, factory setup and confirmation should be obtained before connecting to a panel. **(NOTE: Check panel power jumper settings before connection)**
- Controller:** Handle the controller with care as static charge may damage electronic components. Make sure correct jumper and dip switches settings to match the target LCD panel.
- LCD signal cable (LVDS panel):** In order to provide a clean signal it is recommended that LVDS signal cables are no longer than 46cm (18 inches). If those wire cabling is utilized these can be made into a harness with cable ties. Care should be taken when placing the cables to avoid signal interference. Additionally it may be necessary in some systems to add ferrite cores to the cable to minimize signal noise.
- LCD signal cable (Single pixel TTL panel):** In order to provide a clean signal it is recommended that LCD signal cables should not longer than 33cm (13 inches). If loose wire cabling is utilized these can be made into a harness with cable ties. Care should be taken when placing the cables to avoid signal interference. Additionally it may be necessary in some systems to add ferrite cores to the cables to minimize signal noise.
- Inverter:** This will be required for the backlight of an LCD, some LCD panels have an inverter built in. As LCD panels may have 1 or more backlight tubes and the power requirements for different panel backlights may vary it is important to match the inverter in order to obtain optimum performance. See Application notes page 23 for more information on connection.
- Inverter Cables:** Different inverter models require different cables and different pin assignment. Make sure correct cable pin out to match inverter. Using wrong cable pin out may damage the inverter.
- Function Controls:** The following section discusses the controls required and the section on connectors provides the detail. The controls are minimal: On/Off, Backlight Brightness (depends on inverter), OSD (5 momentary buttons) analog VR type or (8 momentary buttons) digital type.
The 8 momentary buttons OSD switch mount P/N 416100520-3 or OSD membrane interface P/N 416100120-3 must be used when 24VDC input.
- Function controls cable:** The cables to the function switches should be of suitable quality and length so that impedance does not affect performance. Generally lengths up to 1 meter (3 feet) should be acceptable.
- Status LED:** The pin direction of the LED should be corrected for right colour indication. Red colour stands for standby. Green colours stands for signal on. The status LED is an optional part only, can be unconnected.
- IR sensor:** It is an optional part only, can be unconnected if not using IR remote control. See Appendix V in details.
- RS-232 control interface :** Firmware upgrade and serial control via this interface port.
- Panel control signal :** Use for specific panel model.
- Audio add-on board P/N 416040010-3:** Provide the interface for the audio add-on board to be connected. The audio add-on board gives the audio input and output signal connection. But the volume cannot be controlled by the OSD menu on the controller. It is an optional part only, can be unconnected if not using audio.
CAUTION : The Audio Add-on Board P/N 416940020-3 is only operate under 12VDC power input environment.
- Ambient light sensor connection :** 3 ways connector provides interface for ambient light sensor connection.

15. Interface for connecting to HD-SDI adaptor board

HD-SDI (1-in-1-out) adaptor board, Kit number P/N 546013410-3 includes :	
HD-1000 adaptor (1-in-1-out)	P/N 416013410-3
Ribbon cable	P/N 426171120-3, 180mm

HD-SDI (2-in-2-out) adaptor board, Kit number P/N 546013310-3 includes :	
HD-2000 adaptor (2-in-2-out)	P/N 416013310-3
Ribbon cable	P/N 426171120-3, 180mm

16. Alternate video input for S-Video and composite video

- HD/SD component video input :** Plug the component video input signal on CNV2 connector

Specifications subject to change without notice

- 18. DVI-D input cable** : Plug the DVI cable to the connector P3 on the controller board
- 19. Analog RGB Input** : As this may affect regulatory emission test results and the quality of the signal to the controller a suitably shielded cable should be utilized.
- 20. S-video input** : Standard S-Video cables can be used. Reasonable quality cable should be used to avoid image quality degradation.
- 21. Composite input** : Composite video input cable with BNC connector can be used. Reasonable quality cable should be used to avoid image quality degradation.
- 22. Auxiliary video input** : This port provides Composite video 1 & 2, S-video 1 & 2, Component 1 & 2. The video input selection can be switched via RS-232 command (0x98).
- 23. Power Input**: 12V/24VDC is required, this should be a regulated supply. The power rating is depending on the panel and inverter used. Normally, power supply with 3.5Amp current output should be enough for most of 4x CCFT panels. Although the controller provides power regulation for the LCD power this does not relate to the power supplied to the backlight inverter. If an unregulated power supply is provided to an inverter any fluctuations in power may affect operation, performance and lifetime of the inverter and or backlight tubes.
- 24. External panel power input** : Allow to supply external power to the panel separately for max 3.3V (7A) or 5V (7A) or 12V (5A) or 18V (3.5A) via PP4 power input connector.
- **Power output**: Note the controller has an overall 3Amp current limit and the current available from the auxiliary power output will be dependent on the power input and other system requirements.
 - **Power Safety**: Note that although only 12V / 24VDC is required as 'power-in' a backlight inverter for panel backlighting produces significantly higher voltages (the inverter does not connect to the ground plane). We strongly advise appropriate insulation for all circuitry.
 - **EMI**: Shielding will be required for passing certain regulatory emissions tests. Also the choice of external Controller to PC signal cable can affect the result.
 - **Ground**: The various PCB mounting holes are connected to the ground plane.
 - **Servicing**: The board is not user serviceable or repairable. Warranty does not cover user error in connecting up to the controller and is invalidated by unauthorized modification or repairs.
 - **Controller Mounting**: It is recommended that a clearance of at least 10mm is provided above and 5mm below the controller when mounted. Additionally consideration should be given to:
 - Electrical insulation.
 - Grounding.
 - EMI shielding.
 - Cable management. Note: It is important to keep panel signal cables apart from the inverter & backlight cables to prevent signal interference.
 - Heat & Ventilation: Heat generated from other sources, for example the backlight of a very high brightness panel may generate significant heat which could adversely affect the controller.
 - Other issues that may affect safety or performance.
 - **PC Graphics Output**: A few guidelines:
 - Signal quality is very important, if there is noise or instability in the PC graphics output this may result in visible noise on the display.
 - Refer to graphics modes table in specifications section for supported modes.
 - Non-interlaced & interlaced video input is acceptable.

IMPORTANT: Please read the Application Notes section for more information.

CONNECTION & OPERATION

CAUTION: Never connect or disconnect parts of the display system when the system is powered up as this may cause serious damage.

CONNECTION

Connection and usage is quite straight forward (it is useful to have the relevant connection diagram available at this time):

1. **LCD panel & Inverter:** Connect the inverter (if it is not built-in the panel) to the CCFT lead connector of the LCD panel.
2. **TTL type (Single pixel) panels:** Plug the signal cables direct to CN3 on the controller board. Plug the other end of cables to the LCD connector board (if connector board is required, otherwise the signal can be direct plug to the LCD panel connector). Then plug the board connector to the LCD panel connector.
3. **LVDS type panels:** The controller board has the built-in LVDS transmitter driver. Plug the LVDS cable to J3. Insert the panel end of the cable the LCD panel connector.
4. **Inverter & Controller:** Plug the inverter cable to CNB1 and CNA1 (if necessary). Plug another end to the connector on the inverter.
5. **Function switch & Controller:** Plug the OSD switch mount cable to CNC1 on the controller board and another to the OSD switch mount.
6. **LED & Controller:** Plug in a 3-way with dual colour LED to connector LED1 on the controller board.
7. **IR & Controller:** Plug in a 3-way with IR sensor to connector IR1 on the controller board.
8. **Jumpers & Switches:** Check all jumpers and switches (SW3, SW4) are set correctly. Details referring the connection diagram (a separate document) or the jumpers and switches setting table (in the following section).
9. **Jumpers & Inverter & Panel voltage:** Particularly pay attention to the settings of JA3, JA5, JA6, JB2 and JB3. JB2 & JB3 are used for inverter control (read inverter specification and information on the jumper table to define the correct settings). JA3 & JA5 & JA6 is used for panel voltage input (read panel specification and information on the jumper table to define the correct settings).
10. **VGA cable & Controller:** Plug the VGA cable to the connector P1 on the controller board.
11. **Power supply & Controller:** Plug the DC 12V/24V power in to the connector PP5 or PP2/3. You can consider to use DigitalView mating power cable P/N 426013800-3, 160mm for PP5 connection.
11. **External panel power input :** Plug power cable : P/N 426013700-3 for external panel power input (3.3 (max 7A) / 5V (max 7A) / 12V (max 5A) / 18V (max3.5))
12. **Power on:** Switch on the controller board and panel by using the OSD switch mount.
13. **Audio Board :** The Audio Add-on Board P/N 416940020-3 is only operate under 12VDC power input environment.

General:

- If you are using supplied cables & accessories, ensure they are correct for the model of panel and controller.
- If you are making your own cables & connectors refer carefully to both the panel & inverter specifications and the section in this manual, "Connectors, Pinouts & Jumpers" to ensure the correct pin to pin wiring.

PC SETTINGS

The controller has been designed to take a very wide range of input signals however to optimize the PC's graphics performance we recommend choosing 60Hz vertical refresh rate – this will not cause screen flicker.

OPERATION

Once the system has been connected and switched on there are a number of functions available to adjust the display image as summarized in the following sections. The settings chosen will be saved for each mode independently.

LCD DISPLAY SYSTEM SETTINGS

NOTE: By way of explanation the following refers to a set of sample buttons that may be obtained as an option. In addition to power on/off and connection for backlight brightness the controller provides an On Screen Display of certain functions which are controlled by 5 momentary type buttons (analog VR type) or 8 momentary type buttons (digital type):

Controls	Analog VR type	Digital type
On/Off – turns controller board power on	VR toggle switch	On/Off button
Brightness – controls backlight brightness	Rotary VR	Brightness +/- buttons
Menu – Turns OSD menu On or Off (it will auto time off) – Back to previous OSD menu page	Menu button	Menu button
Select down – Moves the selector to the next function (down)	SEL DN	SEL DN
Select up – Moves the selector to the previous function (up)	SEL UP	SEL UP
+ – Increase the OSD parameter values – Go into the sub-menu page from the top – Confirm to select the OSD function	+	+
- – Decrease the OSD parameter values – Go into the sub-menu page from the bottom	-	-
Reset to Factory Defaults	Press and hold SEL DN button, then power on the controller	Press and hold SEL DN button, then power on the controller

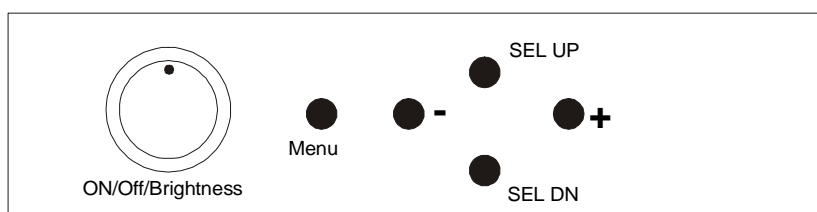

Analog VR type

12V / 24VDC power input :
Analog 10K VR Type OSD
switch mount uses
P/N 410680550-3 or up

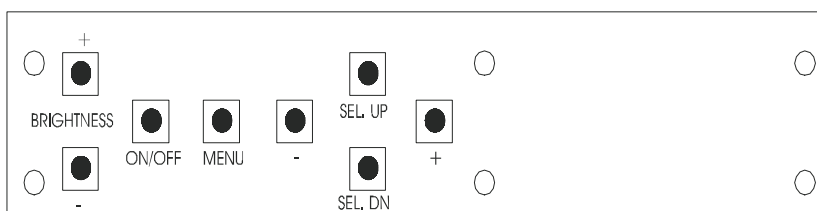

Digital type







12V / 24VDC power input :
Digital 10K Type OSD
switch mount uses
P/N 416100520-3 or up

12VDC power input :
Digital 10K Type OSD
switch mount uses
P/N 416100510-3

OSD functions



Picture :

- Volume^{###}  Increase/decrease volume level, total: 100 steps
- Brightness  Increase/decrease panel brightness level, total: 100 steps
- Contrast  Increase/decrease panel contrast level, total: 100 steps
- Saturation  Increase/decrease saturation, total: 100 steps
- Hue^{**}  Increase/decrease Hue level, total: 100 steps
- Sharpness^{*}  Increase/decrease sharpness, total: 30 steps
- Backlight  Backlight brightness adjustment (Functions when light detector sets OFF)

Position^{##}



Move the image position upward



Move the image position downward



Move the image position to the left



Move the image position to the right

Aspect / Size ▶

- Fill Screen : Enable full screen expansion for lower resolution Image
- Fill to Aspect Ratio: Enable fill screen expansion for lower resolution image according to aspect ratio
- 4 : 3 : scaling format in 4:3
- 16 : 9 : scaling format in 16:9
- 16 : 10 : scaling format in 16:10
- 2.35 : 1 : scaling format in 2.35:1
- 2 : 1 : scaling format in 2:1
- 1 : 1 : Display the exact image resolution on the screen without image expansion.
- Custom Sizing^{####} :
 - Overscan
 - Normal
 - Custom ▶



Blue Only



ON / OFF : Turn off the "Red" & "Green" channel (i.e. output all zero to Red & Green channel)

[This function will display on OSD menu when JP4 – 5-6 closed]

* : DISPLAY IN VIDEO MODE ONLY

** : FUNCTION IN ARGB/ DVI / VIDEO NTSC MODE ONLY

: DISPLAY IN ARGB / DVI MODE ONLY

: FUNCTION IN ARGB MODE ONLY

: DISPLAY WHEN AUDIO ADD-ON BOARD CONNECTED

: DISPLAY IN VIDEO / HD/SD SDI 1 / HD/SD SDI 2 MODE ONLY



Source : Select the input video signal

Main Port Change ▶

- VGA
- DVI
- HD/SD SDI 1***
- HD/SD SDI 2***
- Composite 1
- Composite 2***
- S-Video 1
- S-Video 2***
- Component 1
- Component 2***

PIP Port change ▶

PIP Off / Composite 1 / S-Video 1 / Component 1 / DVI / HD/SD SDI 1

PIP Size ▶ : Off / PIP Size/ 1~18 / Size by Size / Size by Size Tall

The PIP capability on display input sources refer to Appendix VII – PIP mix table

PIP Position :



Move the PIP position upward



Move the PIP position downward



Move the PIP position to the left



Move the PIP position to the right

PIP Blend Level : 6.25% ~ 100%

PIP Swap : Swap between the main window and PIP window

PIP Auto Turn off : OFF ON : OFF / ON

ON : When PIP is no signal input after 30 seconds, the PIP window will turn off automatically.

OFF : PIP window keeps on

*** DISPLAY WHEN SETTING ON UNDER SETUP → AUTO SOURCE SEEK



Utilities :

Setup ▶

Auto Picture Setup# : Auto adjust the image position, phase and size

Auto Color Gain## : Auto Color Calibration (See appendix IV)

Wide Screen Mode detection# ▶ : Recognize the wide screen mode coming from ARGB port

- Off
- 1280x768
- 1360x768
- 1366x768

Manual Clock# : - + Adjust the image horizontal size

Manual Phase# : - + Fine tune the data sampling position (adjust image quality)

Auto Source Seek :

- Auto : OFF ON : OFF / ON

ON – Auto source select always enable

OFF – Disable auto source select function

- Setup ▶ Selection for the corresponding input sources detection

VGA OFF ON

DVI OFF ON

HD/SD SDI 1*** OFF ON

HD/SD SDI 2*** OFF ON

Composite 1 OFF ON

Composite 2 OFF ON

S-Video 1 OFF ON

S-Video 2 OFF ON

Component 1 

Component 2 

The corresponding input port name display on OSD menu will disappear once setting "OFF".

De-interlacing Mode* ▶

AFM  : Auto Film Mode

TNR  : Temporal Noise Reduction

MADI  : Motion Adaptive De-interlacing

DCDi  : Low Angled De-interlacing

[See Appendix VI for AFM, TNR, MADI, DCDi function description]

Auto Power :  OFF / ON

ON – Enable soft power off function if absence of input signals

OFF – Disable soft power function

Video Standard (SD)* : Auto / NTSC / NTSC 4.43 / PAL / PAL M / SECAM

Gamma : 0.6 / 0.7 / 0.8 / 1.0 / 1.6 / 1.8 / 1.9 / 2.0 / 2.1 / 2.2 / 2.3 / 2.4 / 2.5 / 2.6 / User Setting

OSD ▶

OSD position :

H POS  : Move the OSD menu image horizontally

V POS  : Move the OSD menu image vertically

OSD Timeout (sec) : ON – 60 : Adjust the OSD menu timeout period in a step of 5 seconds (max 60 seconds)

ON = Continuous to display OSD menu.

60 = 60 seconds later will turn off the OSD menu.

Language : English / Spanish / French / German / Chinese : Select OSD menu language display

Transparency :  OFF / ON : Set OSD transparency

Display Input :  OFF / ON : Display input source info after switching source.

IR Remote Control : IR Remote Enable : Enable IR Remote control function

IR Remote Disable : Disable IR Remote control function

Freeze : Freeze the image (use "+" button)

Zoom ▶

Zoom level :  : Enable the zoom in function on the image displayed.

Use "+" button to zoom in the image

Use "-" button to decrease the zoomed image

Horizontal pan :  : Pan the image horizontally

Vertical pan :  : Pan the image vertically

Factory Reset

Note : Freeze state will be cleared when you using zoom function.

Color Temperature ▶

5000K

Red Gain : 

Green Gain : 

Blue Gain : 

Red Offset : 

Green Offset : 

Blue Offset : 

Reset to Defaults : Resume to the default values

6500K

Red Gain : 

Green Gain : 

Blue Gain : 

Red Offset : 

Green Offset : 

Blue Offset : 

Reset to Defaults : Resume to the default values

8000K

Red Gain : 

Green Gain :

Blue Gain :

Red Offset :

Green Offset :

Blue Offset :

Reset to Defaults : Resume to the default values

9300K

Red Gain :

Green Gain :

Blue Gain :

Red Offset :

Green Offset :

Blue Offset :

Reset to Defaults : Resume to the default values

User setting :

Red Gain :

Green Gain :

Blue Gain :

Red Offset :

Green Offset :

Blue Offset :

Reset to Defaults : Resume to the default values

Reset All to Defaults : Resume all color temperature settings to the default values.

Hot Key ▶

Hot key 1 : Volume / Brightness / Contrast / Inputs / Aspect Ratio/ Zoom / Freeze / PIP Size / PIP Swap / Saturation / Hue / Backlight / Auto Picture Setup / No Function

Hot key 2 : Volume / Brightness / Contrast / Inputs / Aspect Ratio / Zoom / Freeze / PIP Size / PIP Swap / Saturation / Hue / Backlight / Auto Picture Setup / No Function

Monochrome Mode ▶

- Color
- Red Monochrome
- Green Monochrome
- Blue Monochrome

Backlight Setup ▶

- B/L Invert : : Invert for the backlight brightness
- B/L Control : D/A / PWM : Selection for voltage level dimming control / PWM dimming control
- Backlight Frequency : 100 ~ 440Hz in a step of 20
- Light Detector : : Enable ambient light detector function by using KIT 70220-3

Default Setting ▶

Reset to Factory Defaults ▶ (Activate when JC1 position 4 sets open)
Are you sure ? Yes/No

Reset to Factory Defaults with (Color Temp.) ▶ (Activate when JC1 position 4 sets open)
Are you sure ? Yes/No

Save Current Settings as Calibrated Values ▶ (Activate when JC1 position 2 sets closed)
Are you sure ? Yes/No

Recall Stored Calibrated Values ▶
Are you sure ? Yes/No

* : DISPLAY IN VIDEO MODE ONLY
 *** : DISPLAY WHEN HD-1000/-2000 CONNECTED
 # : DISPLAY IN ARGB MODE ONLY
 ## : DISPLAY IN ARGB OR COMPONENT VIDEO MODE ONLY

Firmware V0.35.00.00 or up revision.

PP2/PP3	Power input (alternative)	DC power Molex 2 pin 0.156" pitch
PP4	External panel power input	Molex 43045-0400 compatible (Matching connector type : Molex 43025-0400 compatible) (Matching power cable : P/N 426013700-3)
PP5	Power input	Molex 43650-0200 compatible (Matching connector type : Molex 43645-0200 compatible) (Matching power cable : P/N 426013800-3)
SW3	Panel selection	8-way DIP Switch
SW4	Function selection	6-way DIP Switch

Summary: Jumpers setting

Ref	Purpose	Note
JA2	On board +3.3V logic power enable	1-2 & 3-4 closed, factory set, do not remove
JA3	Panel power voltage select CAUTION: Incorrect setting can damage panel	See panel voltage setting table 1
JA5	Panel power voltage select CAUTION: Incorrect setting will cause panel damage	See panel voltage setting table 1
JA6	Panel power voltage select CAUTION: Incorrect setting will cause panel damage	See panel voltage setting table 1
JB2	Backlight inverter on/off control – signal level	2-3 = On/Off control signal 'High' = +5V 1-2 = On/Off control signal 'High' = +3.3V Open = On/Off control signal 'High' = Open collector CAUTION: Incorrect setting can damage inverter.
JB3	Backlight inverter on/off control – polarity	1-2 = control signal 'high' = CCFT ON 2-3 = control signal 'low' = CCFT ON
JB5	Backlight control type selection	1-2 = VR/Digital switch mount control 3-4 = Analog backlight brightness - voltage range 0-5V 5-6 = PWM (Pulse Width Modulation) brightness
JC1	Custom configuration	Position 2 : Closed = Enable save Current Settings as Calibrated Values on OSD menu Position 3 : Closed = Enable baud rate selection function in programming mode Position 4 : Closed = Hide "Reset to Factory Defaults" and "Reset to Factory Defaults with (Color Temp.)" from OSD menu.
JC2	Custom configuration	Position 1 : Enable J3 – pin 5 (OP1) controlled by JB4 Position 2 : Enable J3 – pin 6 (OP2) controlled by JB4 Position 3 : Enable J3 – pin 21 (OP3) controlled by JB4 Position 4 : Enable J3 – pin 22 (OP4) controlled by JB4
JP6	Input power control	Short = External switch control Open = Switch mount control
JT1	S-Video Chroma -in terminator enable	Open = S-video chroma input is not terminated Close = S-video chromainput is terminated with 75Ω
JT2	S-Video luma-in terminator enable	Open = S-video luma input is not terminated Close = S-video luma input is terminated with 75Ω
JT3	Composite video-in terminator enable	Open = composite input is not terminated Close = composite input is terminated with 75Ω
JT4	Component luma-in terminator enable	Open = component luma input is not terminated Close = component luma input is terminated with 75Ω
JT5	Component Cb/Pb-in terminator enable	Open = component Cb/Pb input is not terminated Close = component Cb/Pb input is terminated with 75Ω
JT6	Component Cr/Pr-in terminator enable	Open = component Cr/Pr input is not terminated Close = component Cr/Pr input is terminated with 75Ω
JT7	Composite video 2-in terminator enable	Open = composite video 2 input is not terminated Close = composite video 2 input is terminated with 75Ω
JT8	Reserved	Reserved
SW3	Panel & function selection	See table 2
SW4	Panel & function selection	See table 3

Table 1 : Panel voltage setting table :

Input voltage via PP2/PP3, PP5	Panel Voltage	JA3	JA5	JA6	Jumper on board
12VDC	3.3V	3V3 closed	1-3 & 2-4	1-3 & 2-4	
	5V	5V closed	1-3 & 2-4	1-3 & 2-4	
	12V	OPEN	1-3 & 2-4	5-7 & 6-8	

CAUTION: Incorrect setting can damage panel & controller

Input voltage via PP2/PP3, PP5	Panel Voltage	JA3	JA5	JA6	Jumper on board
24VDC**	3.3V	3V3 closed	1-3 & 2-4	1-3 & 2-4	
	5V	5V closed	1-3 & 2-4	1-3 & 2-4	
	12V	12V closed	1-3 & 2-4	3-5 & 4-6	
	18V	18V closed	1-3 & 2-4	3-5 & 4-6	

CAUTION: Incorrect setting can damage panel & controller

**** Ensure that the backlight inverter supports 24V operation prior to connecting a 24VDC input. Because CNA1 pin 1 and CNB1 pin 2 will output 24VDC if input 24VDC via PP2/PP3 or PP5.**

Input voltage via PP4	Panel Voltage	JA3	JA5	JA6	Jumper on board
3.3 / 5 / 12 / 18VDC*	3.3V	OPEN	3-5 & 4-6	1-3 & 2-4	
	5V	OPEN	3-5 & 4-6	1-3 & 2-4	
	12V	OPEN	3-5 & 4-6	3-5 & 4-6	
	18V	OPEN	3-5 & 4-6	3-5 & 4-6	

* Maximum current for 3.3V, 5V = 7A, Maximum current for 12V = 5A, Maximum current for 18V = 3.5A

JA3, JA5 & JA6 location on board : (Please pay attention to the jumper settings on JA3, JA5 & JA6 which are red in color)

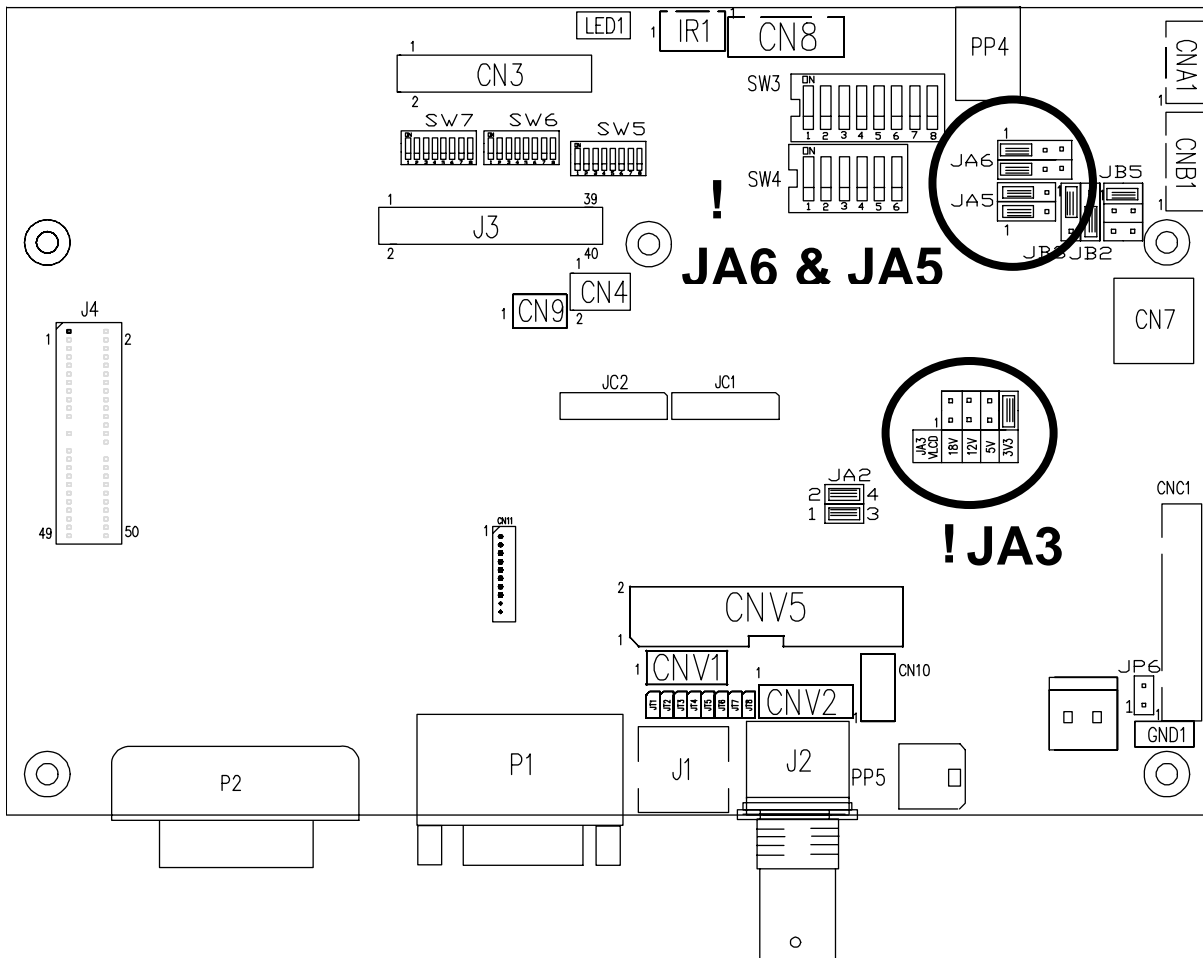

Specifications subject to change without notice

Table 2 : DIP Switch selection – SW3

Pos #1	Pos #2	Pos #3	Pos.#4	Description	Panel resolution
For WUXGA panels					
OFF	ON	ON	OFF	LG LM260WU1-SLB1	1920x1200
ON	ON	ON	OFF	LG LM240WU2-SLA1	1920x1200
OFF	OFF	OFF	OFF	Sharp LQ445D3LZ19	1920x1080
ON	OFF	OFF	OFF	Samsung LTA460H2-L02	1920x1080
OFF	ON	OFF	OFF	Sharp LQ170M1LZ04	1920x1200
ON	ON	OFF	OFF	Samsung LTA700HH-LH1 (1 st trial testing)	1920x1080
OFF	OFF	ON	OFF	Samsung LTA700HH-LH1 (2 nd trial testing)	1920x1080
For UXGA panels					
OFF	OFF	OFF	OFF	Fujitsu FLC59UXC8V-02A	1600x1200
ON	OFF	OFF	OFF	Samsung LTM213U6-L01	1600x1200
For WXGA panels					
OFF	OFF	OFF	OFF	LG LC420W02-A4	1366x768
ON	OFF	OFF	OFF	Sharp LQ315T3LZ24	1366x768
ON	ON	OFF	OFF	Samsung LTA320W2-L01 / LTA230W1-L02	1366x768
ON	ON	ON	ON	NEC NL12876BC26-21 / Samsung LTM170W1-L01	1280x768
OFF	ON	ON	ON	CHI MEI N15414-L01	1280x800
OFF	OFF	ON	OFF	AU Optronics M190PW01	1440x900
OFF	OFF	ON	ON	Sharp LQ072K1LA03 ⁽¹⁾	1280x768
For SXGA panel					
OFF	OFF	OFF	OFF	Sharp LQ181E1LW31	1280x1024
ON	OFF	OFF	OFF	AU Optronics M170EN05	1280x1024
For XGA panel					
OFF	OFF	OFF	OFF	Sharp LQ150X1LGN2A Sharp LQ150X1LGB1	1024x768 1024x768
For SVGA panel					
OFF	OFF	OFF	OFF	Sharp LQ121S1DG11/41 Toshiba LTM08C351	800x600 800x600
For WVGA panel					
OFF	OFF	OFF	OFF	NEC NL8048BC24-01	800x480
ON	OFF	OFF	OFF	Kyocera TCG085WV1AB-G00	800x480
For VGA panel					
OFF	OFF	OFF	OFF	Sharp LQ104V1DG51	640x480
ON	OFF	OFF	OFF	Sharp LQ104V1DG21 Kyocera TCG075VG2AC-G00	640x480 640x480
Others					
OFF	OFF	ON	OFF	Samsung LTI430LA01 ⁽¹⁾	1920x480
OFF	ON	OFF	OFF	AU Optronics M201EW02 V8	1680x1050
OFF	ON	ON	OFF	NEC_NL10260BC1901D ⁽¹⁾	1024x600

(1) Only effective on V0.35.00.00 or up version.

Remark : The above panel timings are copy the panel data direct from SVX-1920. Some of the panel timings settings may not exactly to match the panel model we specified in this table.

Pos #5	Pos #6	Pos #7	Description
OFF	OFF	OFF	WUXGA
ON	OFF	OFF	UXGA
OFF	ON	OFF	SXGA
ON	ON	OFF	WXGA
OFF	OFF	ON	XGA
ON	OFF	ON	SVGA
OFF	ON	ON	VGA
ON	ON	ON	WVGA / Others

Pos. #8	Reserved
---------	----------

Table 3 : DIP switch selection – SW4

Pos. #	Function	Description
1	Reserved	
2	Panel pixel format	OFF : Double Pixel ON : Single Pixel
3	Panel selection	ON : LVDS panel OFF : Reserved
4	LVDS data mapping select (Refer to Table 2)	If SW4 position 5 = OFF (8 bit) OFF : Mapping B ON : Mapping A Please adjust to get the correct picture. See as Appendix I for details of mapping of A and B.
5	Output LVDS display mode selection	OFF : 8 bit
6	Reserved	

CN3 – Panel connector: HIROSE DF20G-50DP-1V (Matching type : DF20A-50DS-1C)

PIN	SYMBOL	DESCRIPTION
1	GND	Ground
2	GND	Ground
3	P_R0	Data bit R0
4	P_R1	Data bit R1
5	P_R2	Data bit R2
6	P_R3	Data bit R3
7	P_R4	Data bit R4
8	P_R5	Data bit R5
9	P_R6	Data bit R6
10	P_R7	Data bit R7
11	P_R8	Data bit R8
12	P_R9	Data bit R9
13	GND	Ground
14	GND	Ground
15	P_G0	Data bit G0
16	P_G1	Data bit G1
17	P_G2	Data bit G2
18	P_G3	Data bit G3
19	P_G4	Data bit G4
20	P_G5	Data bit G5
21	P_G6	Data bit G6
22	P_G7	Data bit G7
23	P_G8	Data bit G8
24	P_G9	Data bit G9
25	GND	Ground
26	GND	Ground
27	P_B0	Data bit B0
28	P_B1	Data bit B1
29	P_B2	Data bit B2
30	P_B3	Data bit B3
31	P_B4	Data bit B4
32	P_B5	Data bit B5
33	P_B6	Data bit B6
34	P_B7	Data bit B7
35	P_B8	Data bit B8
36	P_B9	Data bit B9
37	GND	Ground
38	GND	Ground
39	VS	Vertical sync
40	CLK	Dot clock
41	HS	Horizontal sync
42	DE	Display enable
43	PWR	Power down control signal (5v TTL)
44	VLCD	Panel power supply (3.3v/5v configurable)
45	VLCD	Panel power supply (3.3V/5v configurable)
46	VLCD	Panel power supply (3.3V/5v configurable)
47	NC	No connection
48	VLCD12/18	+12V / +18V panel supply (selected by JA3, JA5 & JA6)
49	VLCD12/18	+12V / +18V panel supply (selected by JA3, JA5 & JA6)
50	VLCD12/18	+12V / +18V panel supply (selected by JA3, JA5 & JA6)

CN4 – Panel connector: HIROSE DF20G-10DP-1V (Matching type : DF20A-10DS-1C)

PIN	SYMBOL	DESCRIPTION
1	OP1	Reserved
2	OP2	Reserved
3	OP3	Reserved
4	OP4	Reserved
5	IP1	Reserved
6	IP2	Reserved
7	IP3	Reserved
8	IP4	Reserved
9	EXT_MSTR2_SDA	Reserved
10	EXT_MSTR2_SCL	Reserved

CN7 - Audio connector: DIL socket header 5x2 right angle [OPERATE UNDER 12VDC POWER INPUT ENVIRONMENT]

PIN	SYMBOL	DESCRIPTION
1	VCC	Audio board logic power supply, +5V
2	VOLSELO	Reserved

Specifications subject to change without notice

3	VOLSEL1	Reversed
4	TUNAUSEL	Reserved
5	CLK/CNT	Reserved
6	GND	Ground
7	+12V/+24V	Audio board power supply, +12V/+24V
8	NC	No connection
9	NC	No connection
10	GND	Ground

CN8 – RS-232 serial control: JST B6B-XH-A (Matching type : XHP-6)

PIN	SYMBOL	DESCRIPTION
1	SDATA	Reserved
2	SCLK	Reserved
3	VCC	+5V
4	TXD	RS-232 Tx data
5	GND	Ground
6	RXD	RS-232 Rx data

CN9 – Ambient light sensor connector : JST B3B-PH-K (Matching type : PHR-3)

PIN	SYMBOL	DESCRIPTION
1	GND	Ground
2	VCC_5V	VCC 5V
3	ALSF	Ambient light sensing feedback

CNA1 - Auxiliary power output: JST B4B-XH-A (Matching type : XHP-4)

PIN	SYMBOL	DESCRIPTION
1	AUX 12V / 24V	+12V / +24V DC, 500mA max
2	GND	Ground
3	GND	Ground
4	AUX 5V	+5V DC, 500mA max

CNA2 - Auxiliary power output: JST B2B-PH-K (Matching type : PHR-2)

PIN	SYMBOL	DESCRIPTION
1	Vcc_5V	+5V DC, 500mA max with fuse
2	GND	Ground

CNB1 – Backlight inverter connector: JST B5B-XH-A (Matching type : XHP-5)

PIN	SYMBOL	DESCRIPTION
1	GND	Ground
2	VBKL	+12V / +24V DC, backlight power supply
3	BLCTRL	On/Off control (enable) – see JB2 & JB3
4	BVR_WIP	Brightness VR – WIP
5	BVR_A	Brightness VR A

CNC1 – Function controls connector: JST B12B-XH-A (Matching type : XHP-12)

PIN	SYMBOL	DESCRIPTION
1	PSWIN	Power switch A
2	SW_ON	Power switch B
3	BVR_A	Backlight brightness VR pin A
4	BVR_WIP	Backlight brightness VR pin WIP
5	BVR_B	Backlight brightness VR pin B (470Ω resistor to +5V Vcc)
6	GND	Ground
7	MENU	OSD menu button
8	-/LEFT	OSD -/Left button
9	+/RIGHT	OSD +/Right button
10	SEL_DN	OSD Select down button
11	SEL_UP	OSD Select up button
12	NC	No connection

The VR for brightness depends on the inverter. The main power load for On/Off is handled by a relay on the controller.

CNV1 – Alternate Video in input, JST B5B-PH-K (Matching type : PHR-5)

PIN	DESCRIPTION
1	S-Video 1 : Chroma in
2	S-Video 1 : Luma in
3	Ground
4	Ground
5	Composite video 1 in

CNV2 – Component Video in input, JST B6B-PH-K (Matching type : PHR-6)

PIN	DESCRIPTION
-----	-------------

Specifications subject to change without notice

1	Y in_1 /Green in
2	Ground
3	Cb/Pb in_1 / Blue in
4	Ground
5	Cr/Pr in_1 / Red in
6	Ground

CNV5 – Auxiliary Video input connector, DIL socket header 13x2

PIN	DESCRIPTION
1	S-Video 1 : Chroma in
2	Ground
3	S-Video 1 : Luma in
4	Ground
5	Composite video 1 in
6	Ground
7	Y in_1
8	Ground
9	Cb/Pb in_1
10	Ground
11	Cr/Pr in_1
12	Ground
13	S-Video 2 : Chroma in
14	Ground
15	S-Video 2 : Luma in
16	Ground
17	Composite video in 2
18	Ground
19	Cr/Pr in_2
20	Ground
21	Y in_2
22	Ground
23	Cb/Pb in_2
24	Ground
25	NC
26	Ground

IR1 – Infra-Red sensor connector: JST B3B-XH-A (Matching type : XHP-3)

PIN	SYMBOL	DESCRIPTION
1	GND	Ground
2	STDBY_Vcc	Stand by voltage
3	IR Data	IR data

J3 – LVDS Panel connector: Hirose, DF13A-40DP-1.25DSA (Matching type : DF13-40DS-1.25C)

PIN	SYMBOL	DESCRIPTION
1	TXA0+	Positive differential LVDS data bit A0
2	TXA0-	Negative differential LVDS data bit A0
3	TXA1+	Positive differential LVDS data bit A1
4	TXA1-	Negative differential LVDS data bit A1
5	OP1	-
6	OP2	-
7	TXA2+	Positive differential LVDS data bit A2
8	TXA2-	Negative differential LVDS data bit A2
9	TXA3+	Positive differential LVDS data bit A3
10	TXA3-	Negative differential LVDS data bit A3
11	TXA4+	Positive differential LVDS data bit A4
12	TXA4-	Negative differential LVDS data bit A4
13	TXAC+	Positive LVDS clock for A channel
14	TXAC-	Negative LVDS clock for A channel
15	TXB4+	Positive differential LVDS data bit B4
16	TXB4-	Negative differential LVDS data bit B4
17	TXB0+	Positive differential LVDS data bit B0
18	TXB0-	Negative differential LVDS data bit B0
19	TXB1+	Positive differential LVDS data bit B1
20	TXB1-	Negative differential LVDS data bit B1
21	OP3	-
22	OP4	-
23	TXB2+	Positive differential LVDS data bit B2
24	TXB2-	Negative differential LVDS data bit B2
25	TXB3+	Positive differential LVDS data bit B3
26	TXB3-	Negative differential LVDS data bit B3

Specifications subject to change without notice

27	GND	Ground
28	GND	Ground
29	TXBC+	Positive LVDS clock for B channel
30	TXBC-	Negative LVDS clock for B channel
31	GND	Ground
32	GND	Ground
33	VDD (3,3V/5V)	Panel power supply (3,3V/5V)
34	VDD (3,3V/5V)	Panel power supply (3,3V/5V)
35	VDD (3,3V/5V)	Panel power supply (3,3V/5V)
36	VDD (3,3V/5V)	Panel power supply (3,3V/5V)
37	NC	No connection
38	VDD +12V / +18V	Panel power supply (+12V/18V) (selected by JA3, JA5 & JA6)
39	VDD +12V / +18V	Panel power supply (+12V/18V) (selected by JA3, JA5 & JA6)
40	VDD +12V / +18V	Panel power supply (+12V/18V) (selected by JA3, JA5 & JA6)

J4 – LVDS Panel connector: Hirose, DF13A-40DP-1.25DSA (Matching type : DF13-40DS-1.25C)

PIN	SYMBOL	DESCRIPTION
1	GND	Ground
2	GND	Ground
3	N.C	No connection
4	N.C	No connection
5	N.C	No connection
6	N.C	No connection
7	CbCr0 (Input)	CbCr0 (Input)
8	Y0 (Input)	Y0 (Input)
9	CbCr1 (Input)	CbCr1 (Input)
10	Y1 (Input)	Y1 (Input)
11	CbCr2 (Input)	CbCr2 (Input)
12	Y2 (Input)	Y2 (Input)
13	CbCr3 (Input)	CbCr3 (Input)
14	Y3 (Input)	Y3 (Input)
15	CbCr4 (Input)	CbCr4 (Input)
16	Y4 (Input)	Y4 (Input)
17	CbCr5 (Input)	CbCr5 (Input)
18	Y5 (Input)	Y5 (Input)
19	CbCr6 (Input)	CbCr6 (Input)
20	Y6 (Input)	Y6 (Input)
21	CbCr7 (Input)	CbCr7 (Input)
22	Y7 (Input)	Y7 (Input)
23	N.C	No connection
24	N.C	No connection
25	VCC(5V)	VCC(5V)
26	VCC (5V)	VCC (5V)
27	CLOCK (Input)	CLOCK (Input)
28	SCLK_TCK(control pin)	SCLK_TCK(control pin)
29	GND	Ground
30	SDIN_TDI(control pin)	SDIN_TDI(control pin)
31	Field (Input)	Field (Input)
32	SDOUT_TDO(control pin)	SDOUT_TDO(control pin)
33	V sync (Input)	V sync (Input)
34	CS_TMS(control pin)	CS_TMS(control pin)
35	H sync (Input)	H sync (Input)
36	GND	Ground
37	GND	Ground
38	N.C	No connection
39	N.C	No connection
40	N.C	No connection
41	HSDSI_LOCK (control pin)	HSDSI_LOCK (control pin)
42	N.C	No connection
43	GND	Ground
44	GND	Ground
45	N.C	No connection
46	N.C	No connection
47	N.C	No connection
48	HSDSI_IPSEL (control pin)	HSDSI_IPSEL (control pin)
49	GND	Ground
50	HSDSI_CAB (control pin)	HSDSI_CAB (control pin)

LED1 – Status LED connector: 3-pin header

PIN	DESCRIPTION
1	Green LED pin (anode)
2	LED pin common (cathode)
3	Red LED pin (anode)

P1 - Analog VGA in - 15 way connector

PIN	SYMBOL	DESCRIPTION
1	PCR	Red, analog
2	PCG	Green, analog
3	PCB	Blue analog
4	ID2	Reserved for monitor ID bit 2 (grounded)
5	DGND	Digital ground
6	AGND	Analog ground red
7	AGND	Analog ground green
8	AGND	Analog ground blue
9	DDC_5V	+5V power supply for DDC (optional)
10	DGND	Digital ground
11	ID0	Reserved for monitor ID bit 0 (grounded)
12	DDC_SDA	DDC serial data
13	HS_IN	Horizontal sync or composite sync, input
14	VS_IN	Vertical sync, input
15	DDC_SCL	DDC serial clock

P2 – DVI-D in

PIN	SYMBOL	DESCRIPTION
1	/RX2	TMDS Data 2-
2	RX2	TMDS Data 2+
3	GND	Digital Ground
4	NC	No connection
5	NC	No connection
6	DDC_CLK	DDC Clock
7	DDC_DAT	DDC Data
8	NC	No connection
9	/RX1	TMDS Data 1-
10	RX1	TMDS Data 1+
11	GND	Digital Ground
12	NC	No connection
13	NC	No connection
14	DDC_5V	+5V power supply for DDC (optional)
15	GND	Ground (+5, Analog H/V Sync)
16	NC	No connection
17	/RX0	TMDS Data 0-
18	RX0	TMDS Data 0+
19	GND	Digital Ground
20	NC	No connection
21	NC	No connection
22	GND	Digital Ground
23	RXC	TMDS Clock+
24	/RXC	TMDS Clock-
C1	NC	No connection
C2	NC	No connection
C3	NC	No connection
C4	HS_IN	Analog horizontal sync
C5	GND	Ground
C6	NC	No connection

PP2/PP3 – Alternate 12V/24VDC power supply

PIN	DESCRIPTION
1	+12VDC / 24VDC in
2	Ground

PP4 – External panel power input

PIN	DESCRIPTION
1	External panel power
2	Ground
3	External panel power
4	Ground

PP5 - 12V/24VDC power supply

PIN	DESCRIPTION
1	+12V / +24VDC
2	Ground

CONTROLLER DIMENSIONS

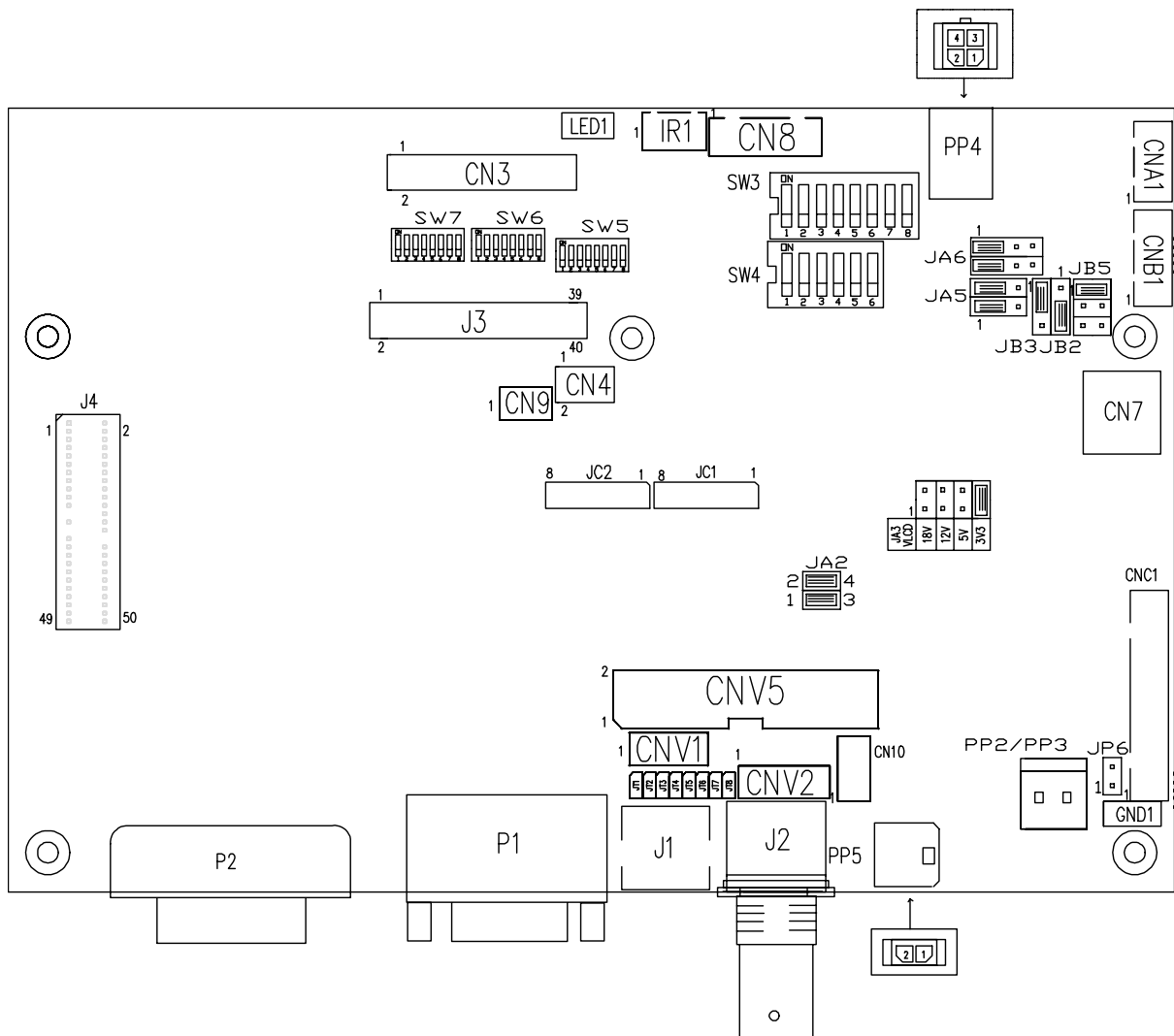

Ready-made 3D Pro-E (SLDPRT) drawing files - Save time and effort for your system volumetric analysis design. Includes jpg file previews. Please go to download at http://www.digitalview.com/drawing/SVH-1920+-2X_3D_Drawing.zip.

The maximum thickness of the controller is 20.65mm with or without video add-on board (measured from bottom of PCB to top of components, including any underside components & leads). We recommend clearances of:

- 5mm from bottom of PCB - if mounting on a metal plate we also recommend a layer of suitable insulation material is added to the mounting plate surface.
- 10mm above the components
- 3~5mm around the edges

Any of the holes shown above can be used for mounting the PCB, they are 3.2mm in diameter.

CAUTION: Ensure adequate insulation is provided for all areas of the PCB with special attention to high voltage parts such as the inverter.

APPLICATION NOTES

USING THE CONTROLLER WITHOUT BUTTONS ATTACHED

This is very straightforward:

- Firstly setup the controller/display system with the buttons. With controls attached and display system active make any settings for colour, tint and image position as required then switch everything off.
- Remove the control switches, the 12-way (CNC1) cable.
- Use a jumper or similar to connect pins 1 & 2 on CNC1, this will fix the board On.
- Refer to inverter specifications for details as to fixing brightness to a desired level, this may require a resistor, an open circuit or closed circuit depending on inverter.

Summary: On CNC1 the only pins that are used are for On/Off and Brightness (if controller mounted inverter is used). On CNC1 the pins are for momentary type buttons so it doesn't matter that no buttons are attached.

INVERTER CONNECTION

There are potentially 3 issues to consider with inverter connection:

- Power
- Enable
- Brightness

Please read the following sections for a guide to these issues.

Inverter Power: As per the table for CNB1 pin 1 is ground and pin 2 provides 12V/24V DC. This should be matched with the inverter specification: see table.

CNB1

PIN	DESCRIPTION
1	Ground
2	+12V/+24VDC

Remark: For higher power inverter, more current (for 12V/24V) can be taken from CNA1 pin 1.

Enable: This is a pin provided on some inverters for On/Off function and is used by this panel controller for VESA DPMS compliance. If the inverter does not have an enable pin or the enable pin is not used then DPMS will not be operational. Pin 3 should be matched to the inverters specification for the 'enable' or 'disable' pin.

CNB1

PIN	DESCRIPTION
3	Enable

Further, jumpers JB2 & JB3 should be set to match the inverters specification for the enable pin power and High or Low setting: see table.

Ref	Purpose	Note
JB2	Inverter enable voltage	1-2 H = 12V/24V, 2-3 H = 5V (Vcc), OPEN H = open collector
JB3	Inverter control	1-2 H = On, 2-3 L = On

Brightness: There are various methods for brightness control and it is important to consider the specifications for the inverter to be used. Generally the situation is:

- Brightness can control by using a resistor or VR (Variable Resistor).
- Brightness controlled by adding a circuit such as PWM (Pulse Width Modulation).
- No adjustment of brightness is possible.

CNB1 pins 4 & 5 are available for connecting to an inverter or circuit where VR control is supported.

CNB1

PIN	DESCRIPTION
4	VR WIP
5	VR A

This can then be matched with function controls connected to CNC1 pins 4 & 3 or 5: see table.

CNC1

PIN	DESCRIPTION
3	VR A
4	VR WIP
5	VR B

Design Guideline for making VR circuitry :

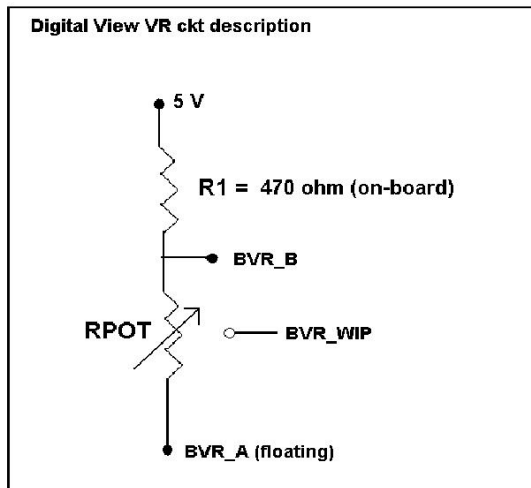

Signal description / Notes :

- 1) R1 : 470ohm on board
- 2) RPOT is an external potentiometer (in-line dip style) that can be plugged directly into CNC1 pins 3,4,5. RPOT must be supplied / installed by user.
- 3) BVR_B : Voltage tapped from “top” of potentiometer, the node of R1 and RPOT.
- 4) BVR_WIP : Voltage tapped from wiper arm of RPOT.
- 5) BVR_A : Voltage tapped from “bottom” of RPOT.

Note : BVR_A voltage is left floating on the controller board. To use this circuit, you need to tie this point to a potential (usually GND, available at CNC1 pin 6).

CNB1 – Backlight inverter connector: JST B5B-XH-A (Matching type : XHP-5)

PIN	SYMBOL	DESCRIPTION
1	GND	Ground
2	VBKL	+12V/24VDC, backlight power supply
3	BLCTRL	On/Off control (enable) – see JB2 & JB3
4	BVR_WIP	Brightness VR - WIP
5	BVR_A	Brightness VR A

CNC1 – Control switch, JST B12B-XH-A (Matching type : XHP-12)

PIN	SYMBOL	DESCRIPTION
1	PSWIN	Power button A
2	SW_ON	Power button B
3	BVR_A	Backlight Brightness VR pin A
4	BVR_WIP	Backlight Brightness R pin WIP
5	BVR_B	Backlight Brightness VR pin B (470 ohm resistor to +5V Vcc)
6	GND	Ground
7	MENU	OSD menu
8	-/LEFT	OSD -/Left
9	+ /RIGHT	OSD +/Right
10	SEL_DN	OSD Select down
11	SEL_UP	OSD Select up
12	NC	No connection

The VR for brightness depends on the inverter. The main power load for On/Off is handled by a relay on the controller.

Example for circuit design :

- 1.) Choose RPOT = 10K
- 2.) Tie BVR_A to GND
- 3.) Circuit analysis gives BVR_WIP as the following (see Figure 1)

$$BVR_WIP = 5 \times (Rbc/10.47)$$

where BVR_WIP is in Volts.
And Rbc is the resistance from the wiper arm to bottom of pot in Kohms.

To evaluate, plug in different values of Rbc :

Rbc	BVR_WIP
0	0 V
2.5 K	1.2 V
5 K	2.4 V
7.5 K	3.6 V
10 K	4.8 V

So this circuit could provide Brightness adjust voltage ranging from 0V to 5V.

Specifications subject to change without notice

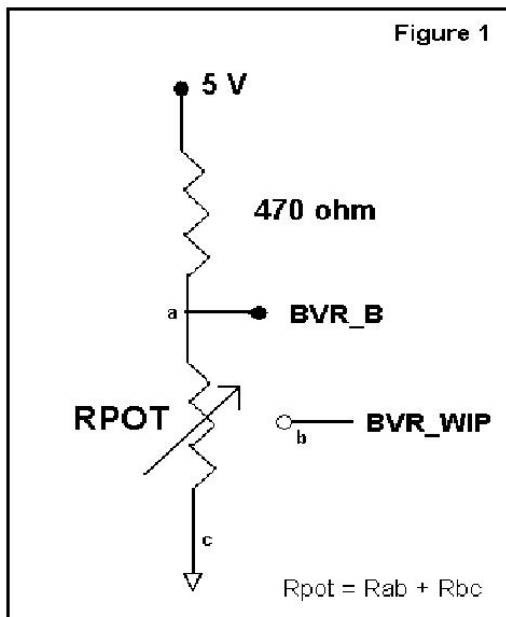

TROUBLESHOOTING

General

A general guide to troubleshooting a flat panel display system it is worth considering the system as separate elements, such as:

- Controller (jumpers, PC settings)
- Panel (controller, cabling, connection, panel, PC settings)
- Backlight (inverter, cabling, backlight tubes)
- Cabling
- Computer system (display settings, operating system)

Through step by step cross checking with instruction manuals and a process of elimination to isolate the problem it is usually possible to clearly identify the problem area.

No image:

- If the panel backlight is not working it may still be possible to just see some image on the display.
- A lack of image is most likely to be caused by incorrect connection, lack of power, failure to provide a signal or incorrect graphic card settings.

Image position:

If it is impossible to position the image correctly, i.e. the image adjustment controls will not move the image far enough, then test using another graphics card. This situation can occur with a custom graphics card that is not close to standard timings or if something is in the graphics line that may be affecting the signal such as a signal splitter (please note that normally a signal splitter will not have any adverse effect).

Image appearance:

- A faulty panel can have blank lines, failed sections, flickering or flashing display
- Incorrect graphics card refresh rate, resolution or interlaced mode will probably cause the image to be the wrong size, to scroll, flicker badly or possibly even no image.
- Incorrect jumper settings on the controller may cause everything from total failure to incorrect image. CAUTION: Do not set the panel power input incorrectly.
- Sparkling on the display: faulty panel signal cable.

Backlight:

Items to check include: Power input, Controls, Inverter and Tubes generally in this order.

If half the screen is dimmer than the other half:

- Check cabling for the inverter.
- For a specific backlight tube check the AC pins orientation (CAUTION: Never reverse any DC power pins).

Also:

- If adjusting brightness control has no effect the chances are that the VR rating or method of adjusting brightness is not compatible or correctly connected to the inverter.
- If system does not power down when there is a loss of signal

Continued failure:

If unit after unit keeps failing consider and investigate whether you are short circuiting the equipment or doing something else seriously wrong.

Generally after common sense issues have been resolved we recommend step by step substitution of known working parts to isolate the problem.

SPECIFICATIONS

Panel compatibility	Compatible with 1920x1200, 1920x1080, 1920x480, 1680x1050, 1600x1200, 1440x900 1366x768, 1280x1024, 1024x768, 1024x600, 800x600 & 640x480 resolutions of TFT LCD panels. A specified BIOS and some factory adjustment may be required for individual panel timings.
No. of colours	Up to 3 x 8 bit providing 16.7 million colours.
Panel power	DC 3.3V, 5V, 12V, 18V
Panel signal	LVDS, TTL single pixel
Vertical refresh rate	60Hz at 1920x1200, 60Hz at 1920x1080, 60Hz at UXGA and up to 75Hz other lower resolution
Display clock maximum	165MHz
ADC clock maximum	195 MHz
DVI differential input clock maximum	165MHz
Graphics formats	Standard VESA VGA, SVGA, XGA, SXGA, WXGA, UXGA, WUXGA Other special formats through specified BIOS and factory adjustment.
Graphics auto mode detect	VGA, SVGA, XGA, SXGA, WXGA, UXGA & WUXGA interlaced and non-interlaced
Standard input at source (analog RGB)	VGA analog (15 pin) standard with automatic detection of: Digital Separate Sync; Composite Sync Sync On Green.
Video formats	PAL, NTSC & SECAM
Video inputs	ARGB DVI-D Composite video 1 Composite video 2 S-Video 1 S-Video 2 Component video 1 Component video 2 HD-SDI 1 HD-SDI 2
Functions display	On screen display (OSD) of functions
OSD menu functions	Image controls: Panel brightness/contrast, Saturation, Hue, Color temperature, Sharpness, Video Scaling, PIP, OSD position, OSD timeout, Image orientation, Auto Source Seek, etc.
OSD menu controls available	Power On/Off Backlight brightness OSD Menu OSD Select up OSD Select down Setting + Setting -
Control interface	Buttons, RS-232, Remote control
Settings memory	Settings are stored in non volatile memory
PC Connectivity	VGA / SVGA / XGA / SXGA / UXGA / WUXGA analog or digital
Controller dimensions	179mm x 120.4mm (7." x 4.74")
Power consumption	10w approx. (not including panel power consumption)
Power load maximum	The controller has an overall 3Amp current limit.
Input voltage	12V/24VDC +/- 5%
Power protection	Fuse fitted (Resettable)
DC Power handling	Reverse power polarity protection is equipped on the board
Storage temperature limits	-40°C to +70°C
Operating temperature limits	0°C to +60°C

NOTES

Please note the following:

- For specific panel setup a sample of an LCD may be required (this will be returned) and a copy of the full technical specifications for the panel from the manufacturer.
- Re-layout and custom development services are available.

APPENDIX I – SIGNAL SUPPORT MODE TABLE

ARGB (P1) PORT :

Mode	Resolution	Clk [MHz]	Horizontal freq [KHz]	Vertical freq [Hz]	Sync Mode
T_70	720x400 70Hz	28.322	31.469	70.087	Digital Separate Sync
T_70	720x400 70Hz	28.322	31.469	70.087	Sync On Green
V_60	640x480 60Hz	25.175	31.469	59.940	Digital Separate Sync
V_60	640x480 60Hz	25.175	31.469	59.940	Sync On Green
V_60	640x480 60Hz	25.175	31.469	59.940	Composite Sync
V_72	640x480 72Hz	31.500	37.861	72.809	Digital Separate Sync
V_72	640x480 72Hz	31.500	37.861	72.809	Sync On Green
V_72	640x480 72Hz	31.500	37.861	72.809	Composite Sync
V_75	640x480 75Hz	31.500	37.500	75.000	Digital Separate Sync
V_75	640x480 75Hz	31.500	37.500	75.000	Sync On Green
V_75	640x480 75Hz	31.500	37.500	75.000	Composite Sync
SV_56	800x600 56Hz	36.000	35.156	56.250	Digital Separate Sync
SV_56	800x600 56Hz	36.000	35.156	56.250	Sync On Green
SV_56	800x600 56Hz	36.000	35.156	56.250	Composite Sync
SV_60	800x600 60Hz	40.000	37.879	60.317	Digital Separate Sync
SV_60	800x600 60Hz	40.000	37.879	60.317	Sync On Green
SV_60	800x600 60Hz	40.000	37.879	60.317	Composite Sync
SV_72	800x600 72Hz	50.000	48.077	72.188	Digital Separate Sync
SV_72	800x600 72Hz	50.000	48.077	72.188	Sync On Green
SV_72	800x600 72Hz	50.000	48.077	72.188	Composite Sync
SV_75	800x600 75Hz	49.500	46.875	75.000	Digital Separate Sync
SV_75	800x600 75Hz	49.500	46.875	75.000	Sync On Green
SV_75	800x600 75Hz	49.500	46.875	75.000	Composite Sync
X_60	1024x768 60Hz	65.000	48.363	60.004	Digital Separate Sync

Specifications subject to change without notice

X_60	1024x768 60Hz	65.000	48.363	60.004	Sync On Green
X_60	1024x768 60Hz	65.000	48.363	60.004	Composite Sync
X_70	1024x768 70Hz	75.000	56.476	70.069	Digital Separate Sync
X_70	1024x768 70Hz	75.000	56.476	70.069	Sync On Green
X_70	1024x768 70Hz	75.000	56.476	70.069	Composite Sync
X_75	1024x768 75Hz	78.750	60.023	75.029	Digital Separate Sync
X_75	1024x768 75Hz	78.750	60.023	75.029	Sync On Green
X_75	1024x768 75Hz	78.750	60.023	75.029	Composite Sync
SX_60	1280x1024 60Hz	108	63.81	60.020	Digital Separate Sync
SX_60	1280x1024 60Hz	108	63.81	60.020	Sync On Green
SX_60	1280x1024 60Hz	108	63.81	60.020	Composite Sync
SX_75	1280x1024 75Hz	135	79.976	75	Digital Separate Sync
SX_75	1280x1024 75Hz	135	79.976	75	Sync On Green
SX_75	1280x1024 75Hz	135	79.976	75	Composite Sync
UX_60	1600x1200 60Hz	162	75.000	60	Digital Separate Sync
UX_60	1600x1200 60Hz	162	75.000	60	Sync On Green
UX_60	1600x1200 60Hz	162	75.000	60	Composite Sync
WUX_60	1920x1080 60Hz	172.8	67.5	60	Digital Separate Sync
WUX_60	1920x1080 60Hz	172.8	67.5	60	Sync On Green
WUX_60	1920x1080 60Hz	172.8	67.5	60	Composite Sync
WUX_60	1920x1200 60Hz	193.2	74.5	60	Digital Separate Sync
WUX_60	1920x1200 60Hz	193.2	74.5	60	Sync On Green
WUX_60	1920x1200 60Hz	193.2	74.5	60	Composite Sync

Remark :

The controller has been designed to take a very wide range of input signals however to optimize the PC's graphics performance we recommend choosing 60Hz vertical refresh rate. To support on higher refresh rate over 60Hz, the LCD panel may not support.

COMPOSITE, S-VIDEO & COMPONENT VIDEO INPUT PORT :

System	Resolution	Horizontal freq [KHz]	Vertical freq [Hz]
NTSC	720x480i	15.7	60
NTSC 4.43	720x480i	15.7	60
PAL	720x576i	15.6	50
PAL M	720x576i	15.6	50
SECAM	720x576i	15.6	50

Appendix II – RS-232 control protocols

RS-232 Serial control (Baud rate 2400, 8 bits, 1 stop bit and no parity)

Physical connection :

Controller side
Connector interface : CN8
Mating connector : JST XHP-6

Computer side
Connector interface : Serial port
Mating connector : DB9 Female

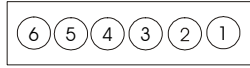

Mating face of CN8

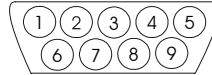

Mating face of RS-232 DB9 Male

PIN#	Description
4	RS-232 Tx Data
5	Ground
6	RS-232 Rx Data

PIN#	Description
2	RS-232 Rx Data
3	RS-232 Tx Data
5	Ground

Remark :

(1) : RS-232 connection cable, 600mm P/N 4260902-00 can be ordered separately for connection.

Software connection :

The OSD function can be controlled through sending the RS-232 protocol.

The RS-232 program can be custom-made to fit for application or it can be used the serial control program, like Accessport, Telix or Serial Utility program developed by DigitalView. Please contact your local support for information.

1. Commands to implement switch mount control buttons

Function	Command	Description	Remark
Menu button	0xf7	Menu button pressed	Button equivalent
Select-down button	0xfa	Select-down button pressed	Button equivalent
Select-up button	0xfb	Select-up button pressed	Button equivalent
Right/+ button	0xfc	Right/+ button pressed	Button equivalent
Left/- button	0xfd	Left/- button pressed	Button equivalent

2. Parameter setting - immediate, relative, reset and query

Function	Command	Description	Acknowledge (if enabled)
Volume control - left+right channel	0x80, "a" "A", nn "+" "-" "r" "R" "?"	Set audio (L+R) volume = value/increment/decrement Reset Query	volume Range : "0"0-"1"E" Default : "0"F"
Volume control - on/off (mute)	0x80, "m" "M", "0" "1" "r" "R" "?"	Disable audio output. Enable audio output. Reset Query	"0" - audio off (muted). "1" - audio on.
Brightness control	0x81, nn "+" "-" "r" "R" "?"	Set brightness = value/increment/decrement Reset Query	Brightness. Range : "4"E-"B"2" Default : "8"0"
Contrast control - all channels	0x82, "a" "A", nn "+" "-" "r" "R" "?"	Set all contrast = value/increment/decrement Reset Query	Contrast Range : "1"C-"E"4" Default : "8"0"
Saturation control	0x83, nn "+" "-" "r" "R" "?"	Set saturation = value/increment/decrement Reset Query	Range : "0"1-"F"F" Default : "8"0"
Hue control	0x84, nn "+" "-" "r" "R" "?"	Set hue = value/increment/decrement Reset Query	NTSC tint (In NTSC mode only) Range : "5"3-"9"F" Default : "7"9"
Phase (tuning) control	0x85, nn "+" "-" "?"	Set dot clock phase = value/increment/decrement Query	Dot clock phase. (In PC mode only)
Image H position	0x86, nnnn "+" "-" "?"	Set img_hpos = value/increment/decrement Query	Image horizontal position. (In PC mode only)
Image V position	0x87, nnnn "+" "-" "?"	Set img_vpos = value/increment/decrement Query	Image vertical position. (In PC mode only)
Sharpness	0x8a, nn "+" "-" "r" "R" "?"	Set sharpness = value/increment/decrement Reset Query	Sharpness. (Video Mode Source only) Range : "F"4-"0"C" Default : "0"0"
Frequency	0x8b, nnnn "+" "-" "?"	Set frequency = Value/increment/decrement Query	Graphic mode H active size (in pixels)
Scaling Mode	0x8c, "0" "1" "2" "3" "9" "A" "B" "C" "D" "r" "R"	Set graphic image scaling mode = value Reset Query	Image expansion on/off. "0" - 1:1 "1" - fill screen "2" - fill to aspect ratio "9" - 4:3

	"?"		"A" – 16:9 "B" – 16:10 "C" – 2.35:1 "D" – 2:1
OSD H position	0x90, nnn "+" "-" "r" "R" "?"	Set osd_hpos = value/increment/decrement Reset Query	OSD horizontal position. Range : "0"0-"F"F Default : "8"0
OSD V position	0x91, nnn "+" "-" "r" "R" "?"	Set osd_vpos = value/increment/decrement Reset Query	OSD vertical position. Range : "0"0-"F"F Default : "8"0
OSD Transparency	0x92, n "+" "-" "r" "R" "?"	Set OSD transparency = value/increment/decrement Reset Query	OSD transparency. "0" – ON "1" – OFF
OSD menu timeout	0x93, nn "+" "-" "r" "R" "?"	Select menu timeout = value/increment/decrement Reset Query	OSD menu timeout value. "0"0 – Continuous. value – Round up to nearest available step. if value > max available step, set it to the max available step. Range : "0"5-"3"C Default : "0"A
Select OSD language	0x95, n "r" "R" "?"	Select language = English, Chinese,... Reset Query	"0" – English. "2" – French "3" – Spanish "6" – German "8" – Chinese
Input main select	0x98, nn "+" "-" "r" "R" "?"	Select input main = PC or VIDEO or next available Reset Query	Main selected. "0x41,0x31" ARGB "0x42,0x31" Composite "0x42,0x32" Composite2 "0x43,0x31" S-video "0x43,0x32" S-video2 "0x44,0x31" Component "0x44,0x32" Component2 "0x45,0x31" HDSDI "0x45,0x32" HDSDI2 "0x46,0x31" DVI
Auto Source Seek	0x99, nn , "0" "1" "?" "o"	Set Auto source enable = *1 Source Disable/ Enable Query Valid Source query	"nn" = "0x41,0x31"- ARGB "0x42,0x31"- Composite "0x42,0x32"- Composite 2 "0x43,0x31"- S-video "0x43,0x32"- S-video 2 "0x44,0x31"- Component "0x44,0x32"- Component 2 "0x45,0x31"- HDSDI "0x45,0x32"- HDSDI2 "0x46,0x31"- DVI
Source Layout	0x9a, n "r" "R" "?"	Select source layout = Single, PIP, PBP, PBPT Reset, Query	Query: "0"- Single "1"- Picture in Picture (PIP) "2"- Picture by Picture (PBP) "3"- Picture by Picture Tall (PBPT)
Video System (Composite, S-video and	0x9b, "0" "1" "2" "3" "r" "R"	Set video system = Auto/NTSC/PAL/SECAM Reset	Query "0" – Auto. "1" – NTSC_M_358

Specifications subject to change without notice

Component Only)	"S" "s" "?"	Video State Query Query	"2" – PAL_N_443 "3" – SECAM "4" – NTSC_M_443 "5" – PAL_M_358 "7" – PAL_M_443 "9" – PAL_N_358 <hr/> Video State Query "0" – No video. "1" – NTSC "2" – PAL "3" – SECAM "4" – NTSC 443 "5" – PAL M 358
GAMMA value select	0x9d, n "r" "R" "?"	Select GAMMA value = Value Reset Query	GAMMA value: "0" – 1.0, "1" – 1.6 "2" – 2.2, "3" – User Defined "4" – 1.7, "5" – 1.8, "6" – 1.9, "7" – 2.0, "8" – 2.1, "9" – 2.3, "A" – 2.4, "B" – 2.5, "C" – 2.6, "D" – 0.6, "E" – 0.7, "F" – 0.8, "G" – 0.9, "H" – 1.1, "I" – 1.2, "J" – 1.3, "K" – 1.4, "L" – 1.5
Auto power off	0x9f, "0" "1" "r" "R" "?"	Set power down option = On/Off Reset Query	"0" – Off. "1" – On.
Hotkey 1	0xa0, "1", n "r" "R" "?"	Set Hotkey 1= Value Reset Query	"1" – volume. "2" – brightness. "3" – contrast. "4" – colour. "5" – input source. "7" – zoom "8" – freeze "9" – PIP "B" – No function "D" – PIP Swap "E" – Aspect Ratio "G" – Hue "H" – Backlight "I" – Auto Picture Setup
Hotkey 2	0xa0, "2", n "r" "R" "?"	Set Hotkey 2 = value Reset Query	"1" – volume. "2" – brightness. "3" – contrast. "4" – colour. "5" – input source. "7" – zoom "8" – freeze "9" – PIP "B" – No function "D" – PIP Swap "E" – Aspect Ratio "G" – Hue "H" – Backlight "I" – Auto Picture Setup
Runtime counter	0xa1,	runtime counter value =	Runtime = nnnnn.

	nnnn "r" "R" "?"	nnnn (* 0.5 hour) Reset Query	
PIP brightness control	0xa2, nn "+" "-" "r" "R" "?"	Set PIP window brightness = value/increment/decrement Reset Query	PIP window brightness. Range : "4"E-"B"2" Default : "8"0"
PIP contrast control	0xa3, nn "+" "-" "r" "R" "?"	Set PIP window contrast = value/increment/decrement Reset Query	PIP window contrast. Range : "1"C-"E"4" Default : "8"0"
PIP H position	0xa4, nnn "+" "-" "r" "R" "?"	Set PIP_hpos = value/increment/decrement Reset Query	PIP window horizontal position. Range : "0"0"0"0-"0"6"4" Default : "0"5"5"
PIP V position	0xa5, nnn "+" "-" "r" "R" "?"	Set PIP_vpos = value/increment/decrement Reset Query	PIP window vertical position. Range : "0"0"0"0-"0"6"4" Default : "0"1"4"
PIP window size select	0xa6, nn "r" "R" "?"	Select PIP window size = PIP window size value Reset Query	Main selected. PIP off if "nn" = "0"0". "0"0"0"~"1"2" "0"0" ~ "1"2" "1"9" : Size by Size "1"A" : Size by Size Tall
PIP source select	0xa7, n "r" "R" "?"	Select input main = Video source value Reset Query	Main selected. 0x40 0x30 : PIP OFF* 0x41, 0x31 : ARGB 0x42, 0x31 : Composite 0x43, 0x31 : S-video 0x44, 0x31 : Component 1 0x45, 0x31 : HDSDI 1 0x46, 0x31 : DVI 0x42, 0x32 : Composite 2 0x43, 0x32 : S-video 2 0x44, 0x32 : Component 2 0x45, 0x32 : HDSDI 2
Zoom level	0xa8, nnnn "+" "-" "r" "R" "?"	Set Zoom level = value/increment/decrement Reset Query	Zoom level. Min : 0x30 0x30 0x30 0x30 (Default) Max : 0x30 0x30 0x41 0x33
Zoom H position	0xa9, nnnn "+" "-" "r" "R" "?"	Set Zoom_hpos = value/increment/decrement Reset Query	Zoom window horizontal position. Default : 0x30 0x30 0x30 0x30 The min and max values will change depends on input resolution.
Zoom V position	0xaa, nnnn "+" "-" "r" "R" "?"	Set Zoom_vpos = value/increment/decrement Reset Query	Zoom window vertical position. Default : 0x30 0x30 0x30 0x30 The min and max values will change depends on input resolution.
Horizontal Size	0xad, nnn "+" "-" "r" "R" "?"	Set horizontal size for Aspect Size = value/increment/decrement Reset Query	Scalar horizontal stretch PAL(576i) / NTSC (480i) : Min : 0x30 0x30 0x30 (Default) Max : 0x30 0x46 0x30

Specifications subject to change without notice

Vertical Size	0xb0, nnn "+" "-" "r" "R" "?"	Set Vertical Size for Aspect Size = value/increment/decrement Reset Query	Scalar vertical stretch. PAL(576i) / NTSC (480i) : Min : 0x30 0x30 0x30 (Default) Max : 0x30 0x46 0x30
Horizontal Pan	0xb1, nnn "+" "-" "r" "R" "?"	Set horizontal pan position for Aspect Size = value/increment/decrement Reset Query	Scalar horizontal pan position PAL(576i) / NTSC (480i) : Assume max H-Size & max V-size : Min : 0x46 0x38 0x38 Max : 0x30 0x37 0x38 Default : 0x30 0x30 0x30 The min and max values will change depends on different value of H-Size, V-Size and input resolution.
Vertical Pan	0xb2, nnn "+" "-" "r" "R" "?"	Set Vertical pan position for Aspect Size = value/increment/decrement Reset Query	Scalar vertical pan position PAL(576i) / NTSC (480i) : Assume max H-Size & max V-size : Min : 0x46 0x38 0x38 Max : 0x30 0x37 0x38 Default : 0x30 0x30 0x30 The min and max values will change depends on different value of H-Size, V-Size and input resolution.
Colour temperature select	0xb3, n "r" "R" "?"	Select colour temperature = value Reset Query	Main selected. "0" – 9500K. "1" – 8000K. "2" – 6500K. "3" – 5000K "4" - User
Red level for selected colour temperature	0xb4, nn "+" "-" "r" "R" "?"	Set the level of the red channel for the selected colour temp. = value/increment/decrement Reset Query	Red level for selected colour temperature. Range : "9" "C" - "F" "F" Default : "E" "C"
Green level for selected colour temperature	0xb5, nn "+" "-" "r" "R" "?"	Set the level of the green channel for the selected colour temp. = value/increment/decrement Reset Query	Green level for selected colour temperature. Range : "9" "C" - "F" "F" Default : "E" "C"
Blue level for selected colour temperature	0xb6, nn "+" "-" "r" "R" "?"	Set the level of the blue channel for the selected colour temp. = value/increment/decrement Reset Query	Blue level for selected colour temperature. Range : "9" "C" - "F" "F" Default : "E" "C"
Graphic horizontal resolution enquiry	0xb7	Horizontal resolution (in pixels) in 3 digit hex number	"nnn" = horizontal resolution
Graphic vertical resolution enquiry	0xb8	Vertical resolution (in lines) in 3 digit hex number	"nnn" = vertical resolution
Graphic horizontal sync frequency enquiry	0xb9	Horizontal sync frequency (in units of 100Hz) in 3 digit hex number	"nnn" = horizontal frequency
Graphic vertical sync frequency enquiry	0xba	Vertical sync frequency (in units of Hz) in 3 digit hex number and 1 char	"nnnn" = vertical frequency nnn = 3 digit hex c= "i" or "p"

			interlace or Progressive 0xba added the interlace(i) or Progressive(p) feedback.
OSD status enquiry	0xbb	Status of OSD	"0" – OSD turned off "1" – OSD turned on
OSD turn off	0xbd	Turn off the OSD.	"1" – successful.
Set gamma data for user defined gamma curve	0xbf, mm, c, "?" 0xbf, "R" "r" 0xbf, mm, c, nn	Query gamma data for color c index mm (c = 0 for color Red, c=1 for color Green, c=2 for color Blue) Set user gamma curve to linear Set gamma data for color c index mm. (If c= 3, then gamma data for red, green & blue will be set at the same time.)	"nn" = gamma data "1" "nn" = gamma data
Backlight control	0xe0, nn "+" "-" "R" "r" "?"	Set Backlight = value/increment/decrement Reset Query	Backlight. Range: D/A : "0"0" ~ "1"0" 100Hz : "0"0" ~ "B"0" 120Hz : "0"0" ~ "9"0" 140Hz : "0"0" ~ "8"8" 160Hz : "0"0" ~ "7"7" 180Hz : "0"0" ~ "6"A" 200Hz : "0"0" ~ "5"0" 220Hz : "0"0" ~ "5"6" 240Hz : "0"0" ~ "4"0" 260Hz : "0"0" ~ "4"9" 280Hz : "0"0" ~ "4"4" 300Hz : "0"0" ~ "3"0" 320Hz : "0"0" ~ "3"B" 340Hz : "0"0" ~ "3"7" 360Hz : "0"0" ~ "3"4" 380Hz : "0"0" ~ "3"1" 400Hz : "0"0" ~ "2"0" 420Hz : "0"0" ~ "2"D" 440Hz : "0"0" ~ "2"B"
Backlight On/Off	0xe1, "0" "1" "R" "r" "?" "S" "s"	Backlight Off / Backlight On /Status	"0" – Backlight Off "1" – Backlight On. "?" – Backlight On/Off Query "S" "s" – Backlight Status Query
Color Monochrome mode selection (Output Channel Select)	0xe2 "0" "1" "2" "3" "4" "5" "6" "R" "r" "?"	Off/ Blue Only/ Red Only/ Green Only/ Blue Mono/ Red Mono/ Green Mono/	"0" – Off "1" – Blue Only "2" – Red Only "3" – Green Only "4" – Blue Mono "5" – Red Mono "6" – Green Mono
PIP Swap	0xe3	Swap Main and PIP source	"0" - Fail. "1" - Successful.
Backlight D/A / PWM	0xe5 "0" "1" "R" "r" "?"	Set : PWM or D/A Reset Query	"0" – PWM "1" – D/A
Backlight PWM Frequency	0xe6, nnn "+" "-" "R" "r" "?"	Set Backlight PWM Frequency = value/increment/decrement Reset Query	+/- 20Hz Value 100Hz : "0", "6", "4" 120Hz : "0", "7", "8" 140Hz : "0", "8", "C" 160Hz : "0", "A", "0"

			180Hz : "0","B","4" 200Hz : "0","C","8" 220Hz : "0","D","C" 240Hz : "0","F","0" 260Hz : "1","0","4" 280Hz : "1","1","8" 300Hz : "1","2","C" 320Hz : "1","4","0" 340Hz : "1","5","4" 360Hz : "1","6","8" 380Hz : "1","7","C" 400Hz : "1","9","0" 420Hz : "1","A","4" 440Hz : "1","B","8"
Backlight Invert	0xe7 "0" "1" "R" "r" "?"	Set On or Off Reset Query	"0" – Off "1" – On
Red Offset for selected colour temperature	0xe8, nn "+" "-" "r" "R" "?"	Set the Offset of the red channel for the selected colour temp. = value/increment/decrement Reset Query	Red Offset for selected colour temperature.
Green Offset for selected colour temperature	0xe9, nn "+" "-" "r" "R" "?"	Set the Offset of the green channel for the selected colour temp. = value/increment/decrement Reset Query	Green Offset for selected colour temperature.
Blue Offset for selected colour temperature	0xea, nn "+" "-" "r" "R" "?"	Set the Offset of the blue channel for the selected colour temp. = value/increment/decrement Reset Query	Blue Offset for selected colour temperature.
PIP Window Transparency	0xed, nn "+" "-" "R" "r" "?"	Select PIP Transparency Level PIP Transparency value Reset Query	PIP Transparency "0"F" = 6.25% "0"E" = 12.5% "0"D" = 18.75% "0"C" = 25% "0"B" = 31.25% "0"A" = 37.5% "0"9" = 43.75% "0"8" = 50% "0"7" = 56.25% "0"6" = 62.5% "0"5" = 68.75% "0"4" = 75% "0"3" = 81.25% "0"2" = 87.5% "0"1" = 93.75% "0"0" = 100%.
PIP Window Auto Off	"0xee", "0x41" "0" "1" "?"	Auto Off / Auto On Query	"0"- Off "1"- On
Custom Sizing	0xef, "0" "1" "2" "?"	Custom sizing selection : Overscan / Normal / Custom Query	"0" – Overscan "1" – Custom "2" – Normal

Function	Command	Description	Acknowledge (if enabled)
Send Display Mark	0xF1, "S" "0x21" "0x40" "0x60" "0x7E" Return "1"	"S" = "0x53 or 0x73" ASCII "0x21,0x40,0x60,0x7E" Return " 0x31"	"S" – Send Command "Text" – Character "1" - successful.

Specifications subject to change without notice

e.g Send Display Mark RS232 Code: "0xF1 0x53 0x21" Return Code: "0xF1 0x53 0x21 0x31"			
Clear Display Mark	0xF1, "C" Return "1"	"C" = "0x43 or 0x63" Return " 0x31"	"C" – Clear command "1" - successful.
e.g Clear Display Mark RS232 Code: "0xF1 0x43" Return Code: "0xF1 0x43 0x31"			
Display Mark Horizontal Position	0xF1, "H" "ss" Return "nn"	"H" = "0x48 or 0x68" ----- "nn" = "0x30,0x30~0x46,0x46"	"H" – Horizontal Position command "ss" – Set Horizontal Position number "nn" – Return Position number
e.g Set Display Mark Horizontal Position RS232 Code: "0xF1 0x48 0x30 0x31" Return Code: "0xF1 0x48 0x30 0x31 0x30 0x31"			
Display Mark Vertical Position	0xF1, "V" "ss" Return "nn"	"V" = "0x56 or 0x76" ----- "nn" = "0x30,0x30~0x46,0x46"	"V" – Vertical Position command "ss" – Set Vertical Position number "nn" – Return Position number
e.g Set Display Mark Vertical Position RS232 Code: "0xF1 0x56 0x30 0x31" Return Code: "0xF1 0x56 0x30 0x31 0x30 0x31"			
Display Mark Background Transparency	0xF1, "B" "N" Return "n"	"B" = "0x42 or 0x62" Set Transparency command ----- "N" = "0x30~0x46" Transparency Value (Rang 00~0F)	"B" - Transparency command "N" – Transparency Value "n"- Return Value 0x00 =opaque
Set Display Mark background Transparency value is 8 RS232 Code: "0xF1 0x42 0x38" Return Code: "0xF1 0x42 0x38 0x38"			

3. Other control

Function	Command	Description	Acknowledge (if enabled)
Select RS-232 acknowledge	0xc1, "0" "1"	Disable/enable command acknowledge.	"0" – acknowledge disabled. "1" – acknowledge enabled.
Auto-setup	0xc3	Start auto-setup of current vmode.	"0" – fail. "1" – successful.
Command availability	0xc4, n	Check whether a command is available.	"0" – not available. "1" – available.
Auto-calibration	0xc5	Start auto-calibration of gain of the RGB amplifier.	"0" – fail. "1" – successful.
Freeze frame	0xc6, "0" "1"	Unfreeze / freeze frame	"0" – unfreeze. "1" – freeze.
Soft Power On/Off	0xc8, "0" "1" "?"	Soft power off/on query	"0" – Turn off the LCD power and backlight. Turn off memory controller, Power down DVI Power down ADC, Power down Fclk PLL "1" – Turn on the unit
Query video input status	0xc9	Query the status of the primary & pip status	"nn,nn" = input status "nn,xx" digit = primary status: "0", "0" : invalid "A", "1" ARGB "B", "1" Composite "B", "2" Composite 2

			<p>“C”, “1” S-video “C”, “2” S-video 2 “D”, “1” Component “D”, “2” Component 2 “E”, “1” HDS DI “E”, “2” HDS DI 2 “F”, “1” DVI</p> <p>“xx, nn”= PIP input status: “0”, “0”: invalid “A”, “1” ARGB “B”, “1” Composite “B”, “2” Composite 2 “C”, “1” S-video “C”, “2” S-video 2 “D”, “1” Component “D”, “2” Component 2 “E”, “1” HDS DI “E”, “2” HDS DI 2 “F”, “1” DVI</p>
Video de-interlace method	0xca, “0” “1” “r” “R” “?”	De-interlace mode Reset Query	<p>“3” “1” - enable AFM “3” “0” - disable AFM “4” “1” - enable TNR “4” “0” - disable TNR “5” “1” - enable MADI “5” “0” - disable MADI “7” “1” - enable DC Di “7” “0” - disable DC Di</p>
Query BIOS version	0xcb, “0”	Read BIOS version	<p>BIOS version “VV.YY.ZZ” VV = V0 or E0, V0 = Release version E0 = Engineering Sample</p> <p>YY= Version Number</p> <p>ZZ= Customer Number</p>
Query PCBA number	0xcb, “1”	Read PCBA number	<p>“nnnn” = PCBA number SVH-1920+ = “41717”</p>
Reset parameter	0xce	Reset all parameters to default value	<p>“1” – successful.</p>
Wide Screen Mode Selection	0xd9, “0” “1” “2” “r” “R” “?”	Wide Screen Mode Reset Query	<p>“0” – Normal Mode “1” – 1280x768 “2” – 1366x768</p>

The following commands for sending texts by using RS-232 command.

Function	Command	Description	Acknowledge (if enabled)
Send Line	0xF0, ”S” ”LL” ”TEXT” ”0x0A” Return ”1”	”S” = ”0x53 or 0x73” Send command ----- ”LL” = ”0x30,0x31~0x30,0x34” Line number (Rang 0~4 lines) ----- ”Text”= ASCII code, ”0x20~0x7E” Character(Rang 0~34) ----- 0x0A = End of line	”S” – Send Command ”LL” – Line Number ”Text” – Character ”0x0A” – End of Line ”1” - successful.
e.g Display ”Send Text” message on screen: RS232 Code:”0xF0 0x53 0x30 0x31 0x53 0x65 0x6E 0x64 0x20 0x54 0x65 0x78 0x74 0x0A” Return Code: ”0xF0 0x53 0x30 0x31 0x53 0x65 0x6E 0x64 0x20 0x54 0x65 0x78 0x74 0x0A 0x31”			
Clear Line	0xF0, ”C” ”LL” Return ”nn”	”C” = ”0x43 or 0x63” Clear command ----- ”LL” = ”0x30,0x31~0x30,0x34” Line number (Rang 0~4 lines)	”C” – Clear command ”LL” – Line Number ”nn” – Return Line number
e.g. Clear Line 1 RS232 Code: ”0xF0 0x43 0x30 0x31” Return Code: ”0xF0 0x43 0x30 0x31 0x30 0x31”			
Text Window Horizontal Position	0xF0, ”H” ”ss” Return ”nn”	”H” = ”0x48 or 0x68” ----- ”nn” = ”0x30,0x30~0x46,0x46”	”H” – Horizontal Position command ”ss” – Set Horizontal Position number ”nn” – Return Position number
e.g. Set Text Window Horizontal Position RS232 Code: ”0xF0 0x48 0x30 0x31” Return Code: ”0xF0 0x48 0x30 0x31 0x30 0x31”			
Text Window Vertical Position	0xF0, ”V” ”ss” Return ”nn”	”V” = ”0x56 or 0x76” ----- ”nn” = ”0x30,0x30~0x46,0x46”	”V” – Vertical Position command ”ss” – Set Vertical Position number ”nn” – Return Position number
e.g. Set Text Window Vertical Position RS232 Code: ”0xF0 0x56 0x30 0x31” Return Code: ”0xF0 0x56 0x30 0x31 0x30 0x31”			
Left offset*	0xF0, ”O” ”SSS” Return ”nnn”	”O” = ”0x4F or 0x6F” Set Left Offset command ----- ”SSS” = ”0x30,0x30,0x30~ 0x33,0x46,0x46” Offset Value (Rang 000~3ff)	”O” – Left Offset Command ”SSS”- Offset Value (pixels) ”nnn”- Return Value(pixels)
e.g. Set Left Offset = 100 pixels (0x64 (HEX)) RS232 Code: ”0xF0 0x4F 0x30 0x36 0x34” Return Code: ”0xF0 0x4F 0x30 0x36 0x34 0x30 0x36 0x34”			
Background Transparency*	0xF0, ”B” ”N” Return ”n”	”B” = ”0x42 or 0x62” Set Transparency command -----	”B” - Transparency command ”N” – Transparency Value ”n”- Return Value

Specifications subject to change without notice

		"N" = "0x30~0x46" Transparency Value (Rang 00~0F)	0x00 =opaque
Set background Transparency value is 8 RS232 Code: "0xF0 0x42 0x38" Return Code: "0xF0 0x42 0x38 0x38"			
Text Window Horizontal Size	0xF0, "X" "SSS" Return "nnn"	"X" = "0x58" Set Horizontal Size command ----- "SSS" = "0x31,0x45,0x30~ 0x37,0x38,0x30" Horizontal Size Value (Range 000~3ff)	"X" –Horizontal Size "SSS"- Size Value (pixels) "nnn"- Return Value(pixels)
e.g Set Text Window Horizontal Size = 640 pixels (0x280 (HEX)) RS232 Code: "0xF0 0x58 0x32 0x38 0x30" Return Code: "0xF0 0x58 0x32 0x38 0x30 0x32 0x38 0x30"			

* Note :

Please set the "Background Transparency" and "Left offset" commands before the "Send Line" command.

**The RS-232 command strings sent in one time can support up to 380 bytes via CN8 port
The RS-232 command string sent in one time can support up to 50 bytes via CN1 or J1 port.**

**n = 1-byte ascii-coded hex number, e.g., parameter value of 0x1 is represented by "1" (0x31).
mn or nn = 2-byte ascii-coded hex number, e.g., parameter value of 0x1e is represented by "1", "e" | "E" (0x31, 0x6e|0x4e).**

Please refer to the ASCII to Hex convert table below.

Hex to ASCII conversion table

Hex	ASCII	Hex	ASCII	Hex	ASCII	Hex	ASCII
0x30	0	0x41	A	0x61	a	0x2B	+
0x31	1	0x42	B	0x62	b	0x2D	-
0x32	2	0x43	C	0x63	c	0x3F	?
0x33	3	0x44	D	0x64	d		
0x34	4	0x45	E	0x65	e		
0x35	5	0x46	F	0x66	f		
0x36	6	0x47	G	0x67	g		
0x37	7	0x48	H	0x68	h		
0x38	8	0x49	I	0x69	i		
0x39	9	0x4A	J	0x6A	j		
		0x4B	K	0x6B	k		
		0x4C	L	0x6C	l		
		0x4D	M	0x6D	m		
		0x4E	N	0x6E	n		
		0x4F	O	0x6F	o		
		0x50	P	0x70	p		
		0x51	Q	0x71	q		
		0x52	R	0x72	r		
		0x53	S	0x73	s		
		0x54	T	0x74	t		
		0x55	U	0x75	u		
		0x56	V	0x76	v		
		0x57	W	0x77	w		
		0x58	X	0x78	x		
		0x59	Y	0x79	y		
		0x5A	Z	0x7A	z		

Appendix I – Mapping definition

- Definition of Mapping A :

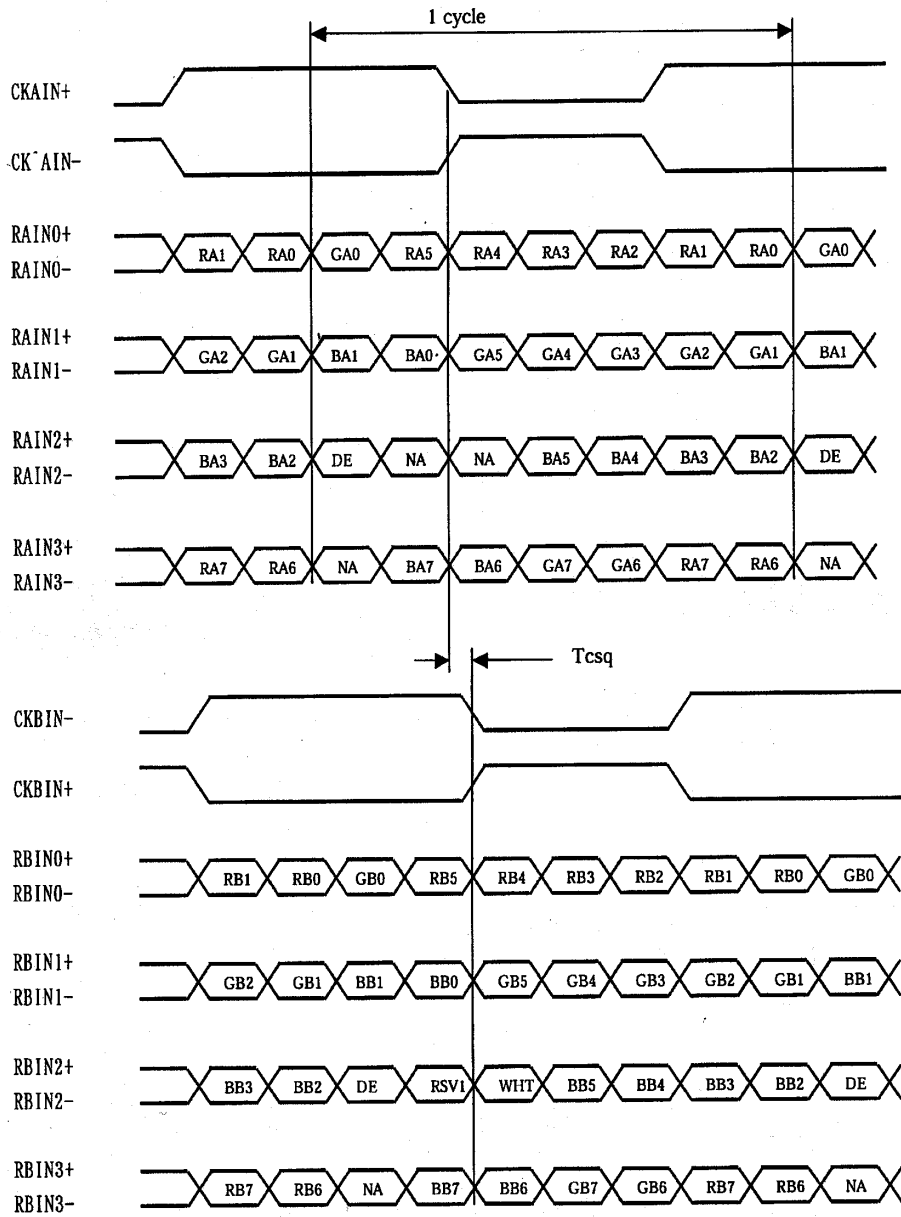

- Definition of Mapping B :

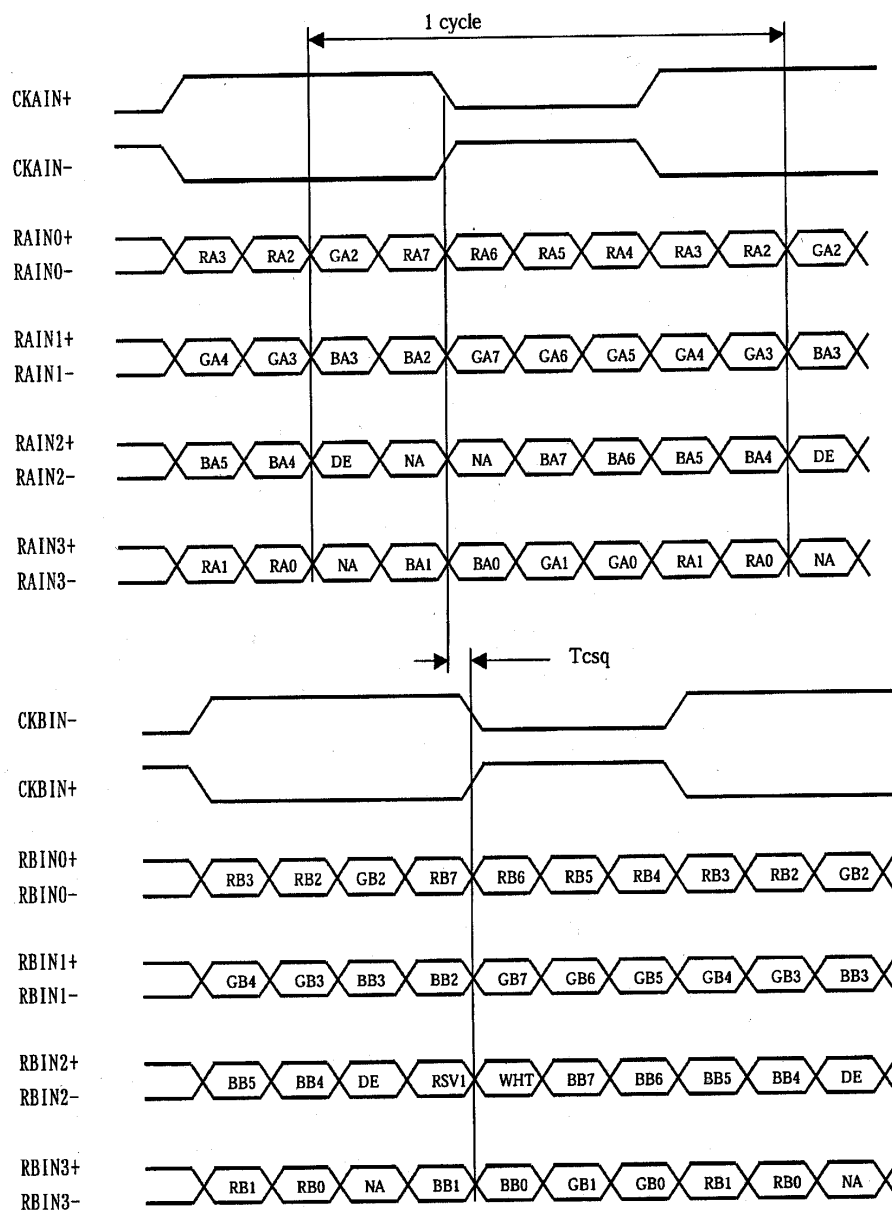

Appendix IV – Auto Color Gain

The Auto Color Gain function is supported in the ARGB or Component video mode only and is designed to calibrate the controller to the incoming video signal. In order to calibrate correctly, the display must be displaying an image containing both black and white data (see illustration below) when the function is used. The internal processor of the video controller chip will then execute a process to adjust the relative values of the RGB signals to achieve the best performance. The parameters of the corrected RGB values are then stored in the controller and are unaffected by the Reset Factory Defaults function.

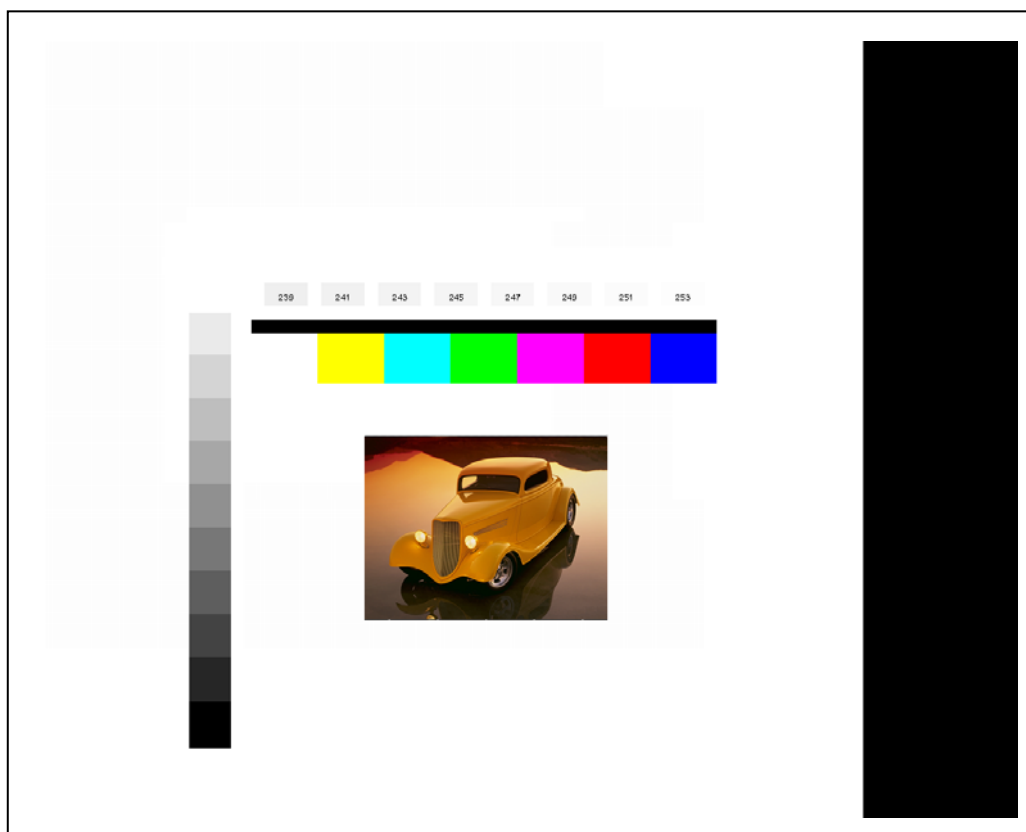

The reference pattern can be downloaded at :

http://www.digitalview.com/support/downloads/TestPattern_1280.BMP

This reference pattern is for 1280x1024 resolution and it needs to set your ARGB input source to 1280x1024 resolution before performing the Auto Color Gain function. The position of the black vertical bar in the pattern at the right side is important. It will affect the calibration result if you are setting the ARGB input to other resolution.

Warning - If the Auto Color Gain is executed without an appropriate image being displayed, then the process will set incorrect values and the display colors will be distorted. If this occurs, then it can either be corrected by performing the process correctly or if this is not possible then the Reset Color Gain function can be used. This function will reset the stored RGB values to a set of approximate values.

Appendix V – DV remote control unit work for SVH-1920+

P/N 559000106-3 :
DigitalView remote control unit
(without DV logo silk screen
printing)

P/N 559000105-3 :
DigitalView remote control unit
(with DigitalView logo silk
screen printing)



BUTTON	FUNCTION
POWER BUTTON	Soft power ON/OFF button.
ATTENTION BUTTON	Use combined with digit keys to enable/disable the IR function. SVH-1920+ : "Attention" + "1"
MUTE BUTTON (MUTE)	Switch to mute on/off mode.
AV/TV BUTTON	Use to select the input source. (VGA/DVI/HDMI/..)
SOUND (ZOOM) BUTTON	Use to display the zoom menu. Press the "+" to zoom in the picture and the "-" to zoom out the picture.
PIP BUTTON	Use to select the PIP (Picture in Picture) setting
SEL UP (▲) / SEL DN (▼)	Use this button to direct control the hotkey function. Press the "SEL UP" button to increase the pre-set hotkey parameter value and the "SEL DN" button to decrease the pre-set hotkey parameter value. In OSD menu, pressing this button to select the items.
VOLUME (-/+) BUTTON	Press the "+" button to increase the volume and the "-" to decrease the volume.
+ / - BUTTON	Use this button to direct control the hotkey function. Press the "+" button to increase the pre-set hotkey parameter value and the "-" button to decrease the pre-set hotkey parameter value. In OSD menu, pressing this button to adjust the settings.
OSD BACK BUTTON	Use to display the OSD menu and go to the previous OSD screen.
OSD NEXT BUTTON	Use to display the OSD menu and go to the next OSD screen.
DISPLAY BUTTON	Use to view an on-screen information. When OSD menu displayed, press this button to turn it off.
TRACK (S-Video) BUTTON	Press this button in the non OSD menu display mode to select S-Video 1 source.
TRACK (Composite 1) BUTTON	Press this button in the non OSD menu display mode to select Composite 1 source.
Composite 2 BUTTON	Press this button in the non OSD menu display mode to select Composite 2 source.
PLAY (YPbPr) BUTTON	Press this button in the non OSD menu display mode to select Component 1 source.
STOP (VGA) BUTTON	Press this button in the non OSD menu display mode to select VGA source.
FREEZE (II) BUTTON	Use this button to freeze and release the picture on your screen.
DVI BUTTON	Press this button in the non OSD menu display mode to select DVI source.
HDSDI1 BUTTON	Press this button in the non OSD menu display mode to select HD-SDI 1 source.
HDSDI2 BUTTON	Press this button in the non OSD menu display mode to select HD-SDI 2 source.

Appendix VI – Function description for de-interlacing mode AFM, TNR, MADi, DCDi

AFM = Auto Film Mode :

It is a frame based method which used for the input ODD and EVEN fields have a fixed relation between each other, such as static image, 3:2 pull down mode.

If two fields are correctly merged, it can get the best quality. But if it merges two wrong fields, it will have artifact and get the worst quality.

TNR = Temporal Noise Reduction :

It is a frame based method which assume field to field have a fixed relationship.

If the object moving too fast, it will have image artifact and get worst quality.

MADi = Motion adaptive de-interlacing :

It is a pixel based method which used for the input fields have no fixed relation between them

If the object moving very too fast, it will get worst quality.

DCDi = Directional Correlation Deinterlacing :

It is a digital enhancement method developed by Faroudja. DCDi technology is primarily used for improving the image quality of low resolution images. This is done by deinterlacing the image and blending rough edges occurring in diagonal lines.

Appendix VII – PIP mix table

	VGA	Composite 1	Composite 2	S-Video 1	S-Video 2	Component 1	Component 2	HD-SDI 1	HD-SDI 2	DVI
VGA	X	✓	✓	✓	✓	✓	✓	✓	✓	✓
Composite 1	✓	X	✓	✓	✓	✓	✓	✓	✓	✓
Composite 2	✓	✓	X	✓	✓	✓	✓	✓	✓	✓
S-Video 1	✓	✓	✓	X	✓	✓	✓	✓	✓	✓
S-Video 2	✓	✓	✓	✓	X	✓	✓	✓	✓	✓
Component 1	✓	✓	✓	✓	✓	X	✓	✓	✓	✓
Component 2	✓	✓	✓	✓	✓	✓	X	✓	✓	✓
HD-SDI 1	✓	✓	✓	✓	✓	✓	✓	X	X	X
HD-SDI 2	✓	✓	✓	✓	✓	✓	✓	X	X	X
DVI	✓	✓	✓	✓	✓	✓	✓	X	X	X

Appendix IX - Inverter Interface Board P/N 416040010-3
[OPERATE UNDER 12VDC POWER INPUT ENVIRONMENT]

The Inverter interface board provides interface to drive up the high current consumption panel inverter in excess of 3.5A. This board enables current of up to 8 Amps to be managed safely while retaining the capability for inverter dimming and management of the inverter enable signal according to VESA DPMS standards. Additionally, the inverter interface board provides over-voltage protection via a resettable fuse when the input voltage exceeds 13V and reverse polarity protection against accidental misconnection.

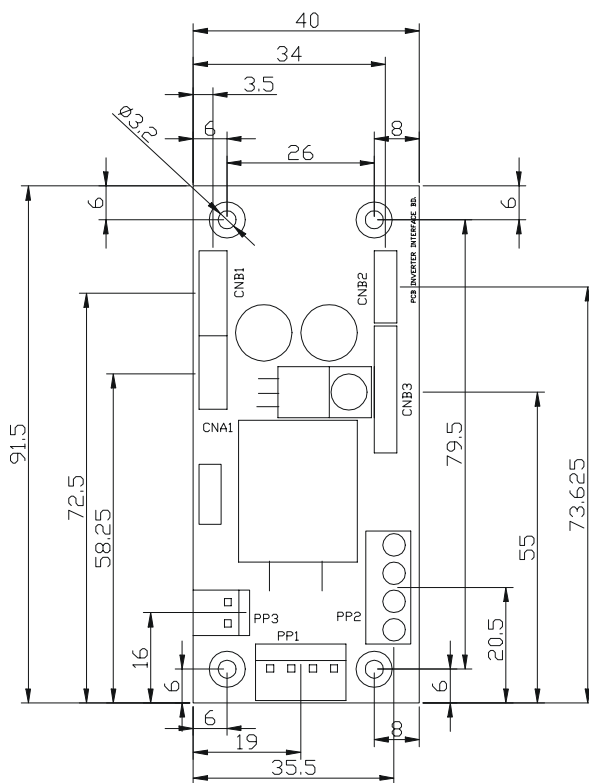

- Connector Type :**
 CNA1, CNB2 : JST 4 ways, B4B-XH-A
 CNB1 : JST 5 ways, B5B-XH-A
 CNB3 : JST 8 ways, B8B-XH-A
 PP1 : PWR 4 way
 PP2 : Terminal Block 2 poles x 2
 PP3 : PWR 2 ways

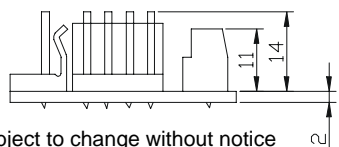

Specifications subject to change without notice

Illustrated Diagram

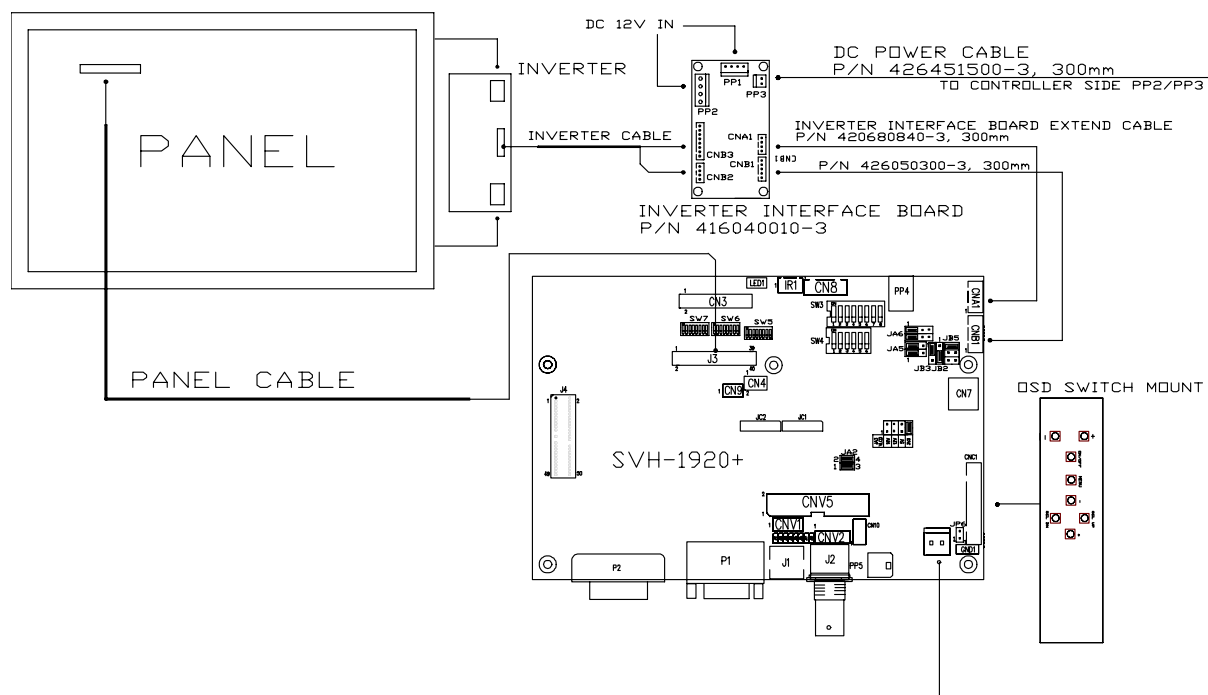

PP1 - 12VDC power supply – input, Power header 4 ways 0.156” pitch

PIN	DESCRIPTION
1	+12VDC
2	+12VDC
3	Ground
4	Ground

PP2 – Alternate 12VDC power supply – input, Terminal Block 2 poles

PIN	DESCRIPTION
1	+12VDC
2	+12VDC
3	Ground
4	Ground

PP3 – 12VDC power supply to controller – Output, Power header 2 ways, 0.156” pitch

PIN	DESCRIPTION
1	+12VDC
2	Ground

CNA1 - Inverter interface to controller, JST B4B-XH-A

PIN	SYMBOL	DESCRIPTION
1	NC	No connection
2	AUX_GND	Ground
3	AUX_GND	Ground
4	AUX_Vcc	+5V DC, 500mA max

CNB1 – Inverter interface to controller, JST B5B-XH-A

PIN	SYMBOL	DESCRIPTION
1	GND	Ground
2	BL_ON	Backlight power
3	BLCTRL	Backlight on/off control signal
4	BVR_WIP	Backlight brightness VR pin WIP
5	BVR_A	Backlight brightness VR pin A

CNB2 – Inverter interface to backlight inverter, JST B4B-XH-A

PIN	SYMBOL	DESCRIPTION
1	VLCD12	Panel power
2	AUX_GND	Ground
3	AUX_GND	Ground
4	AUX_Vcc	+5V DC, 500mA max

Specifications subject to change without notice

CNB3 – Inverter interface to backlight inverter, JST B8B-XH-A

PIN	SYMBOL	DESCRIPTION
1	VLCD12	Panel power
2	VLCD12	Panel power
3	GND	Ground
4	GND	Ground
5	VLCD12	Panel power
6	BLCTRL	Backlight on/off control signal
7	BVR_WIP	Backlight brightness VR pin WIP
8	BVR_A	Backlight brightness VR pin A

Appendix X - Audio Add-on Board P/N 416940020-3
[OPERATE UNDER 12VDC POWER INPUT ENVIRONMENT]

The Audio add-on board P/N 416940020-3 design for connection with DV controllers on the audio connector CN7. It provides audio input ports and output port for sound amplification.



Electrical Specification :

Supply Voltage : +12V, +5V
 Supply current : 35mA for +12V, 6mA for +5V

Input impedance 6.8kohm
 Output power : 2.0W for 4ohm load
 1.0W for 8ohm load

Distortion : <2%
 Voltage gain : 0 to 21 dB

Use of connectors :

Connector	Connector type
CN1	JST B3B-XH-A
CN2	JST B4B-PH-K
CN3	0.1 inches 2 row x 5 pin header strips (right angle)
J1	Ø3.5mm stereo jack socket
J2	Ø3.5mm stereo jack socket

Pin Assignments :

CN1: Output alternate connector

Pin Number	Description
1	Speaker out left
2	Ground
3	Speaker out right

CN2: Input alternate connector

Pin Number	Description
1	Ground
2	Audio input left
3	Ground
4	Audio input right

CN3 : Controller interface connector

Pin Number	Description
1	+5V
2	Left trimpot chip select
3	Right trimpot chip select
4	Trimpot serial data
5	Trimpot serial clock
6	Digital Ground
7	+12V
8	Audio input left
9	Audio input right
10	Audio Ground

Mechanical Drawing :

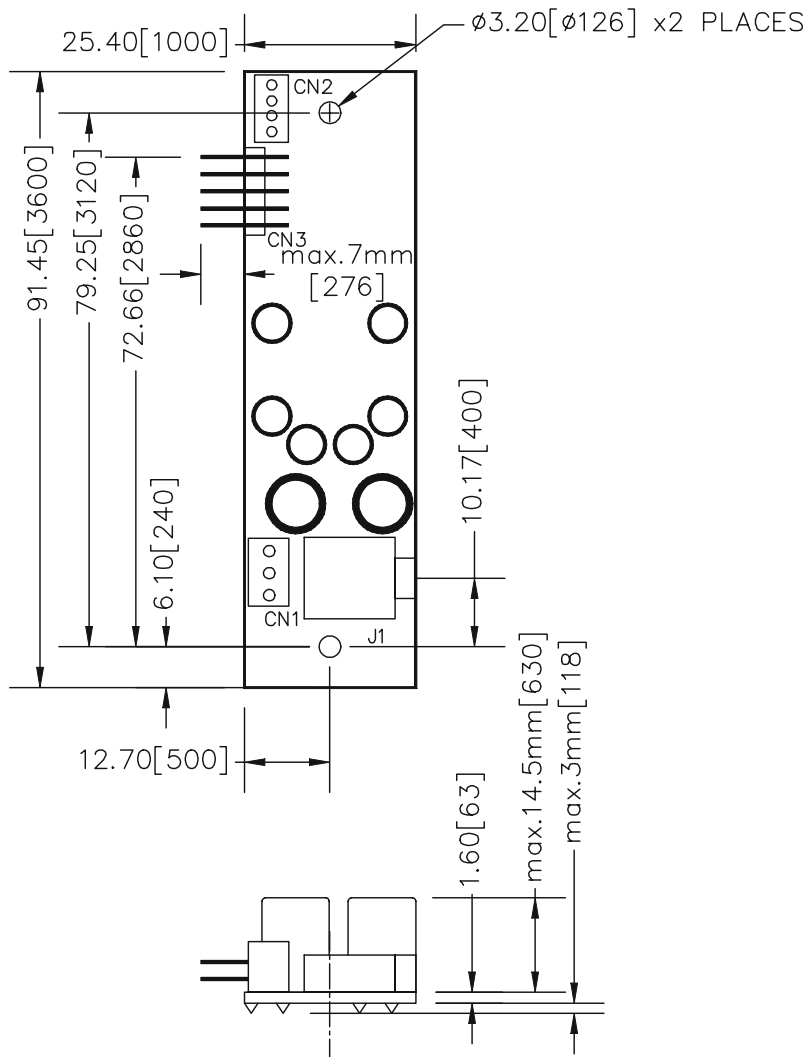

WARRANTY

The products are warranted against defects in workmanship and material for a period of three (3) year from the date of purchase provided no modifications are made to it and it is operated under normal conditions and in compliance with the instruction manual.

The warranty does not apply to:

- Product that has been installed incorrectly, this specifically includes but is not limited to cases where electrical short circuit is caused.
- Product that has been altered or repaired except by the manufacturer (or with the manufacturer's consent).
- Product that has subjected to misuse, accidents, abuse, negligence or unusual stress whether physical or electrical.
- Ordinary wear and tear.

Except for the above express warranties, the manufacturer disclaims all warranties on products furnished hereunder, including all implied warranties of merchantability and fitness for a particular application or purpose. The stated express warranties are in lieu of all obligations or liabilities on the part of the manufacturer for damages, including but not limited to special, indirect consequential damages arising out of or in connection with the use of or performance of the products.

CAUTION

Whilst care has been taken to provide as much detail as possible for use of this product it cannot be relied upon as an exhaustive source of information. This product is for use by suitably qualified persons who understand the nature of the work they are doing and are able to take suitable precautions and design and produce a product that is safe and meets regulatory requirements.

LIMITATION OF LIABILITY

The manufacturer's liability for damages to customer or others resulting from the use of any product supplied hereunder shall in no event exceed the purchase price of said product.

TRADEMARKS

The following are trademarks of Digital View Ltd:

- Digital View
- SVH-1920+

CONTACT DETAILS

Digital View has offices in Asia, Europe and USA :

USA

Digital View Inc.
18440 Technology Drive
Building 130
Morgan Hill,
California, 95037
USA

Tel: (1) 408-782 7773 **Fax:** (1) 408-782 7883

Sales: ussales@digitalview.com

EUROPE

Digital View Ltd.
The Lake House
Knebworth Park
Herts, SG3 6PY
UK

Tel: +44-(0)20-7631-2150 **Fax:** +44-(0)20-7631-2156

Sales: uksales@digitalview.com

ASIA

Digital View Ltd
16 th Floor Millennium City 3
370 Kwun Tong Road
Kwun Tong
Hong Kong

Tel: (852) 2861 3615 **Fax:** (852) 2520 2987

Sales: hksales@digitalview.com

WEBSITE

www.digitalview.com